

Linha

BMS

Processos de
Papéis & Celulose

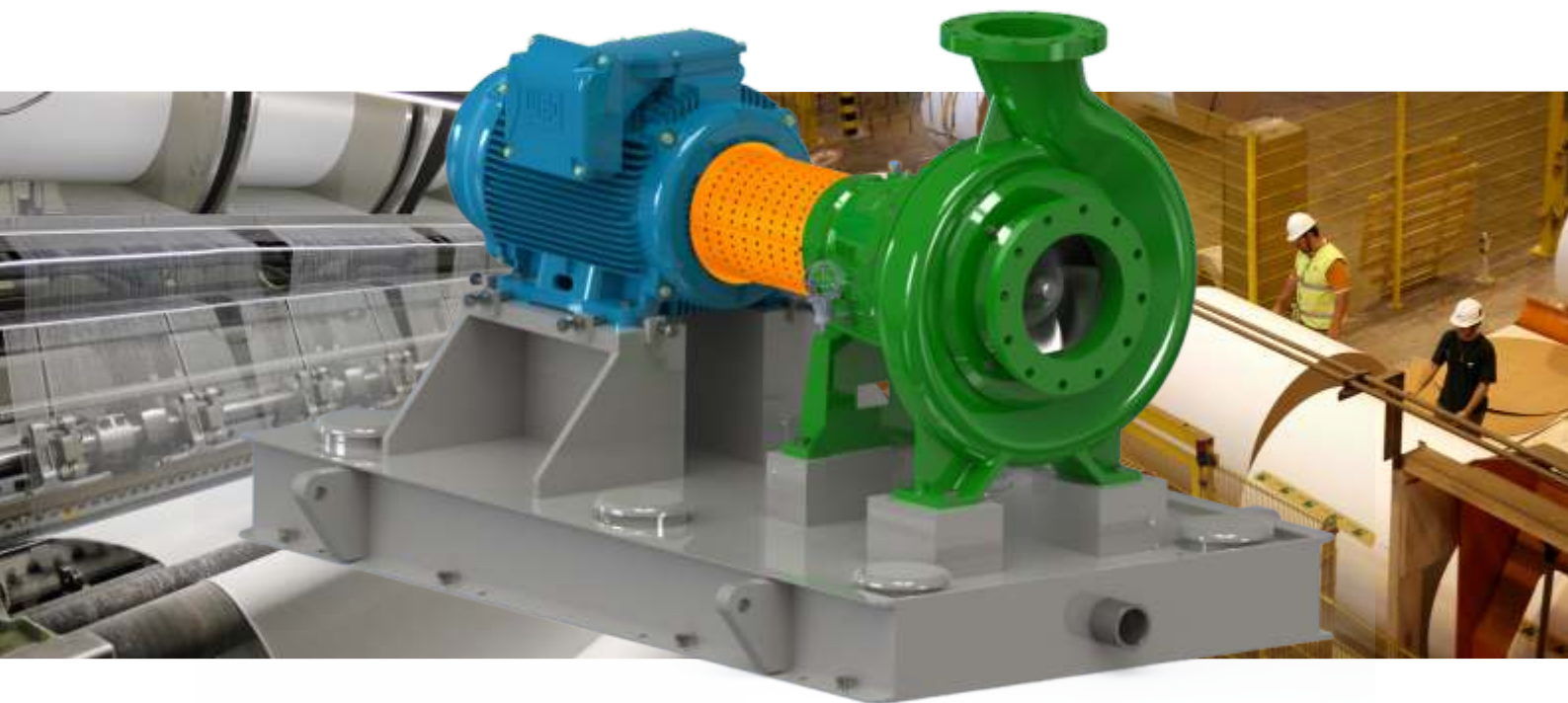

 **IMBIL**®

Soluções em Bombeamento



INTRODUÇÃO

Neste Catálogo estão descritos todos os tamanhos de bombas da linha BMS de nossa fabricação.

Dele constam informações técnicas, desde a construção, aplicação, projeto, características particulares da linha, desenhos dimensionais e curvas características de cada modelo.

INFORMAÇÕES ADICIONAIS

Em caso de dúvidas sobre produtos e serviços, a IMBIL e seus distribuidores, estarão sempre à disposição para prestar informações adicionais e oferecer assistência técnica. Utilize nosso centro de atendimento ao consumidor DDG 0800 148500

DENOMINAÇÃO

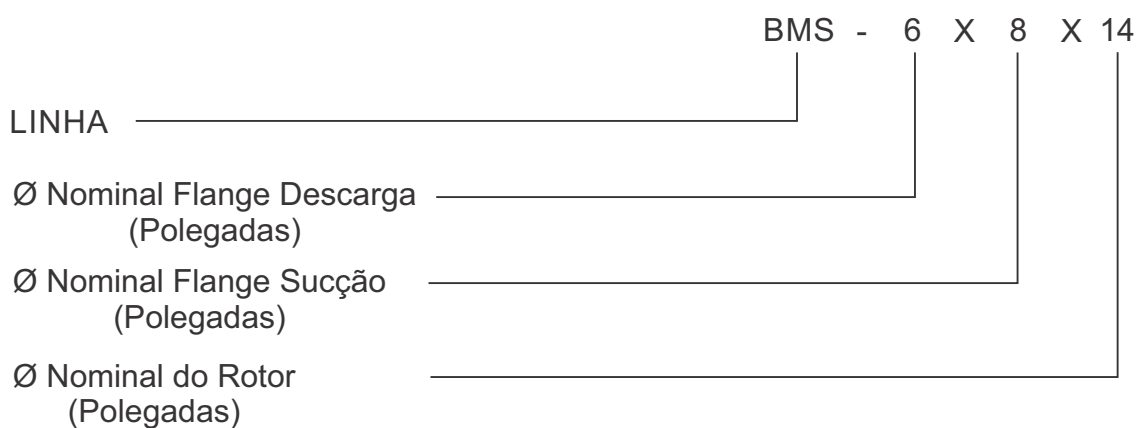

NOTAS

Reservamo-nos o direito de efetuar modificações em nossos produtos, sempre que necessário, sem que, por isso, incorram obrigações de qualquer espécie.



LINHA BMS

As bombas da linha **BMS** são projetadas para serviços severos indicadas principalmente na aplicação de processos de papel e celulose.

CARACTERÍSTICAS & DIFERENCIAIS DE PROJETO

- Back Pull-Out.
- Carcaça com voluta dupla.
- Rotor aberto.
- Ajuste axial externo para retornar a eficiência original.
- Placa de desgaste dianteira (traseira - opcional) preservando e protegendo a voluta e caixa de selagem contra desgaste.
- Várias configurações de selagem e tipos de selos mecânicos disponíveis.
- Projetada e construída para serviços pesados e de alta severidade.
- Intercambiabilidade de peças entre diferentes tamanhos, padronizadas: vários tamanhos de bombas usam o mesmo frame mesma caixa de selagem, ver página 09

APLICAÇÕES

- **Papel e celulose** – Celulose com consistência de até 6%, lixívia negra, serviço hidrodessintegrador e pasta de quebras, circulação de digestor com baixo NPSH, tanque de evacuação para filtros, refúgios dos filtros primários, torre de cloro de alta densidade para lavador, circulação na célula de flutuação;
- **Processos químicos** – Circulação no evaporador, serviços de lama;
- **Petróleo** – Petróleo bruto corrosivo/abrasivo, lama catalisadora, coque fino;
- **Siderurgia** – Desincrustação, tratamento de resíduos, tina venturi, recirculação de eletrolitização;
- **Alimentos** – Polpas de frutas, cuba de grãos e silo de resíduos de malte, recirculação de evaporador, açúcar de beterraba e de cana, produtos de milho;
- **Geral** – Tratamento de resíduos, redução da poluição do ar, águas subterrâneas ácidas, lama têxtil.
- **Açúcar e Álcool** – Fuligem, recirculação de dornas.





CARTA DE APLICAÇÃO

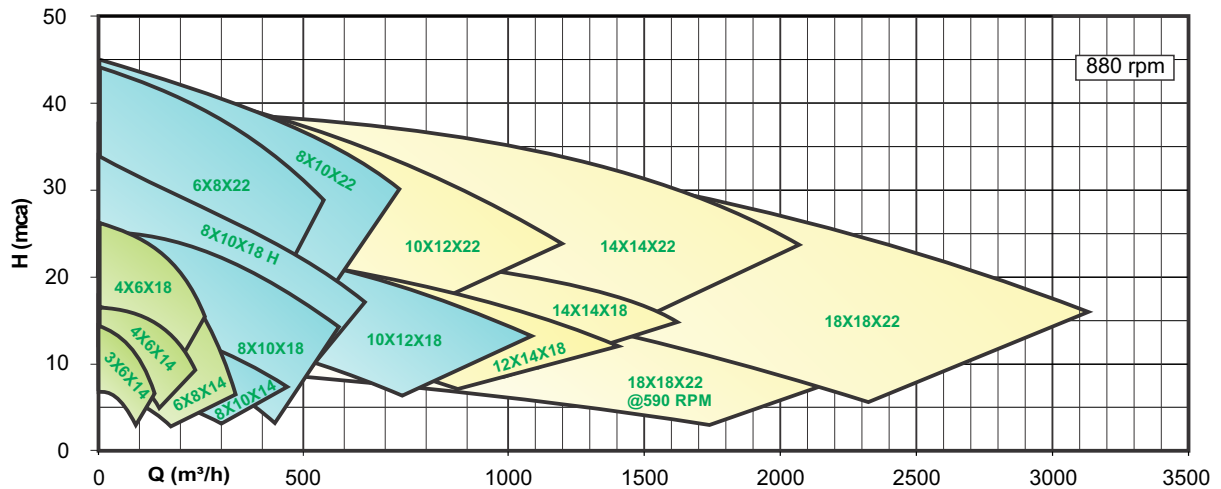
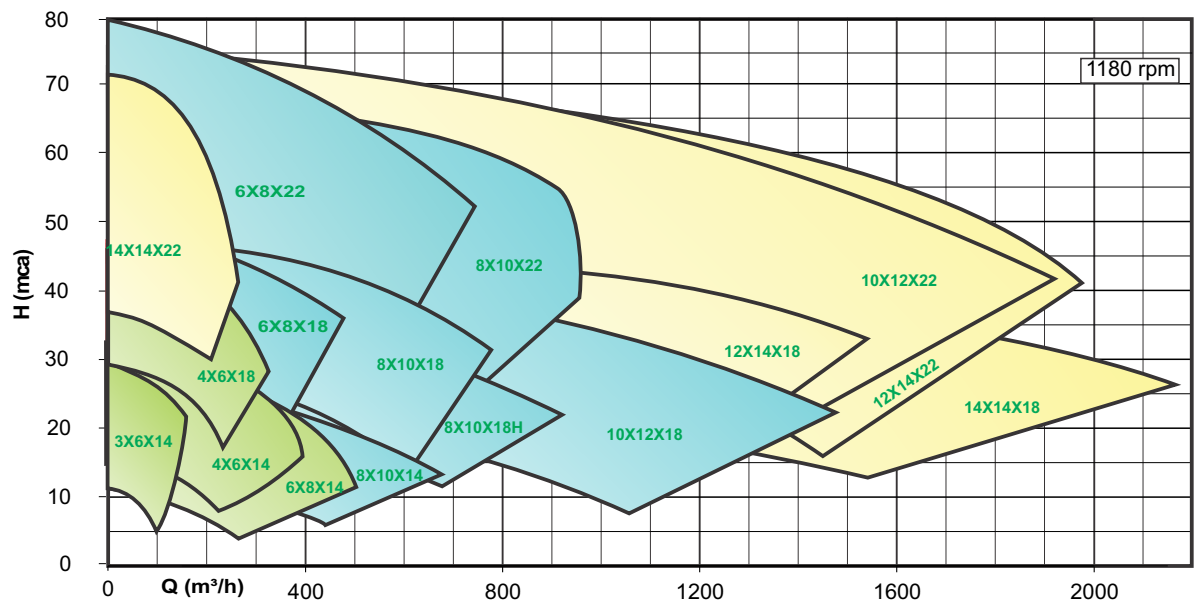
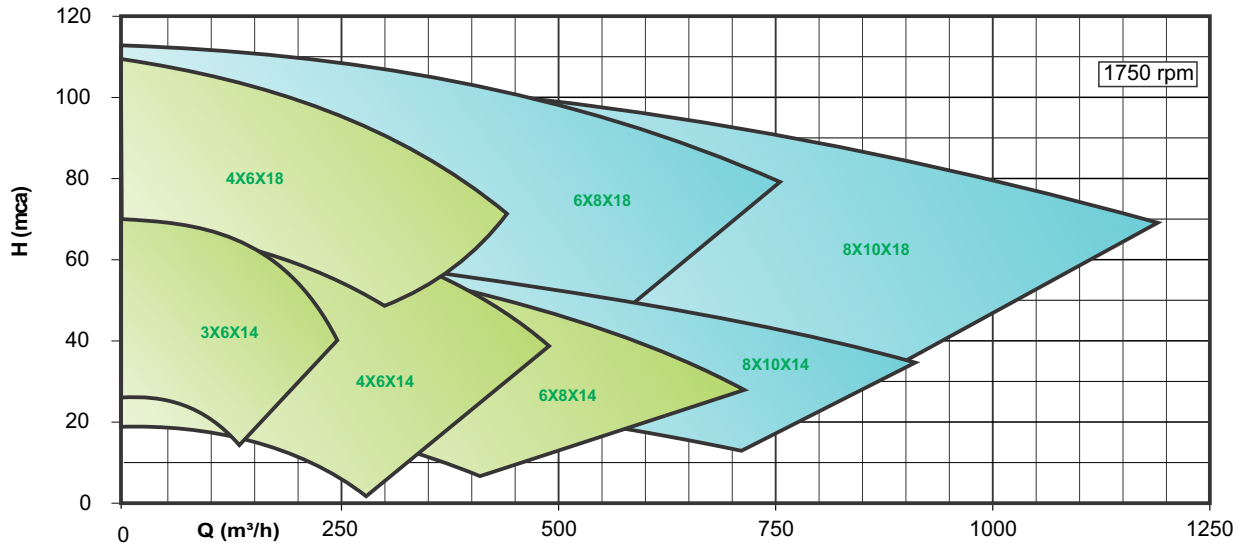



Ajuste de Folga Axial

A folga entre rotor e a placa de desgaste dianteira pode ser facilmente ajustada movendo as partes girantes através do mancal axial de escora para manutenção da eficiência hidráulica. Proporciona economia de energia a longo prazo, ao mesmo tempo que minimiza o tempo de manutenção.

Peças de desgaste renováveis

Baixo custo de manutenção porque todas as peças desgastáveis – placa de desgaste, rotor, caixa de selagem, bucha do eixo - são facilmente substituídas.

Protetores de Mancais, que garantem proteção à caixa de rolamentos (Mancal), não permitindo que haja entrada de impurezas, líquidos corrosivos, ou outros agentes contaminantes que possam comprometer o óleo e danificar os rolamentos.

Disponível também vedação através de retentores.

O **Mancal** tem uma construção reforçada que garante uma alta rigidez ao conjunto e proporciona uma longa vida aos rolamentos, por possuir grande capacidade de armazenamento de óleo lubrificante e aletas externas para melhor arrefecimento. Uma característica muito importante do mancal é que ele foi projetado de forma modular, ou seja, é intercambiável com vários tamanhos de bombas.

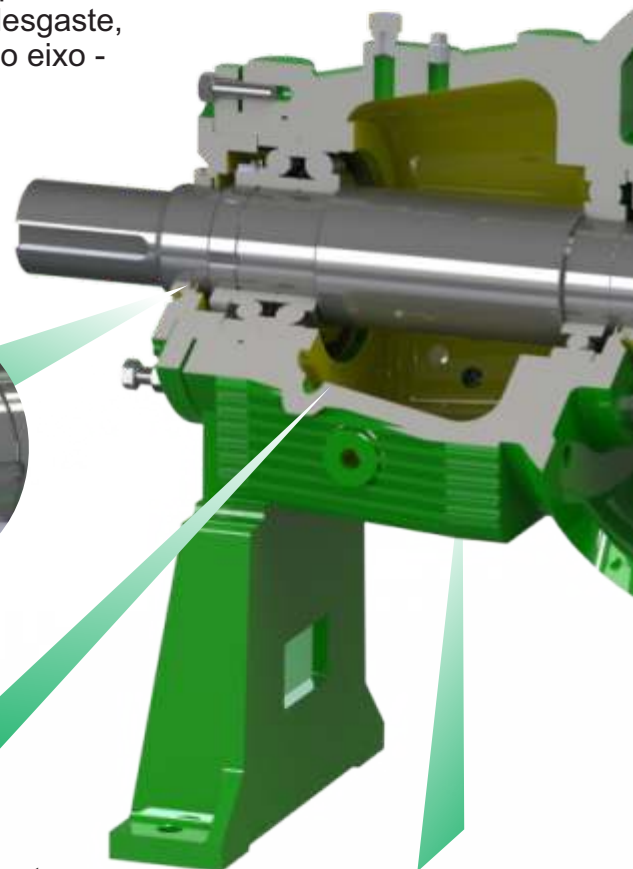
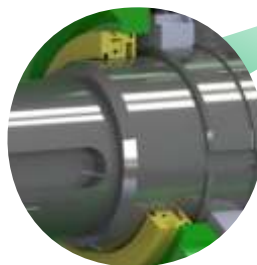

Bujão Magnético para conter e segregar particulado sólido.



SISTEMA DE MONITORAÇÃO

Disponível com monitoração de vibração e temperatura dos mancais axial e radial.

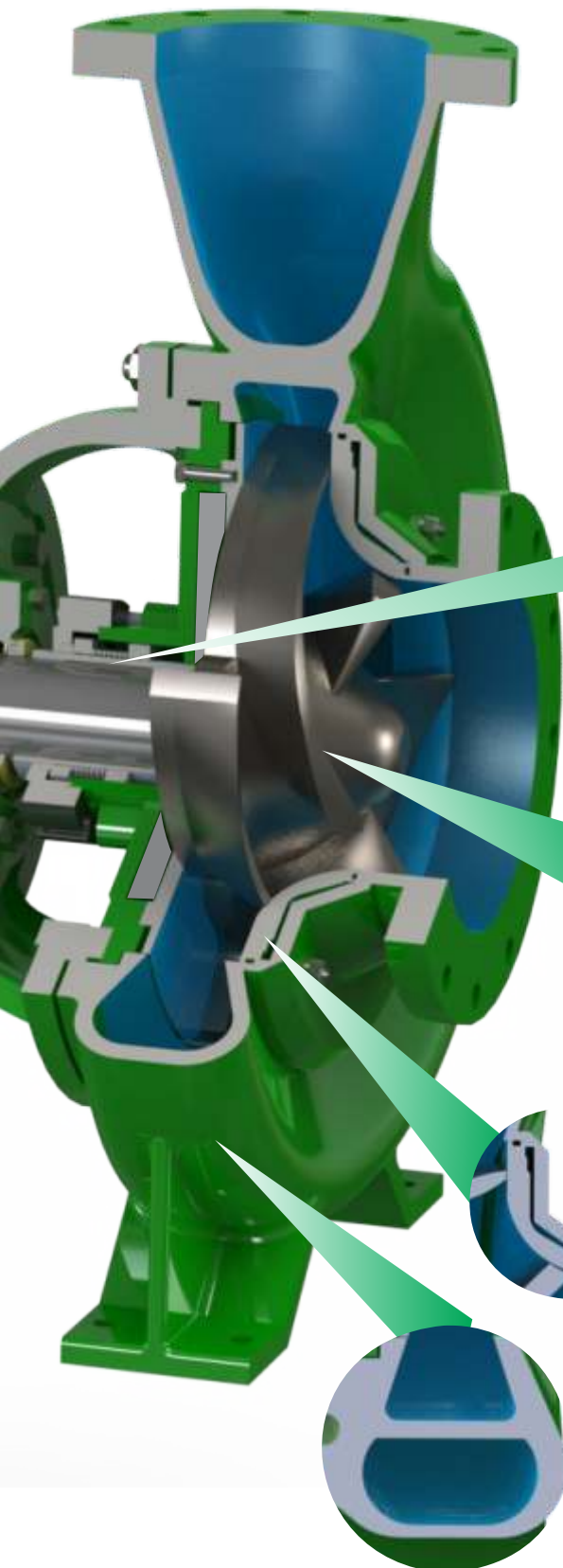

O **Eixo** é dotado de bucha protetora na região da selagem, permitindo que não haja contato do fluido com o eixo.

A vedação do eixo é assegurada por gaxeta na execução Standard ou opcionalmente por selo mecânico, diversos tipos de configurações de planos de selagem.



O **rotor** é aberto, radial de fluxo único, possuem palhetas traseiras que compensam o empuxo axial e impedem o depósito de sólidos na parte traseira.



Placa de desgaste Dianteira objetivando menor custo com manutenção (traseira - opcional).



Carcaça espiral com voluta dupla, fundida em uma única peça, incorporando os pés de fixação com bocal de sucção na horizontal e descarga na vertical na linha de centro (center line auto ventada).



LISTA DE PEÇAS

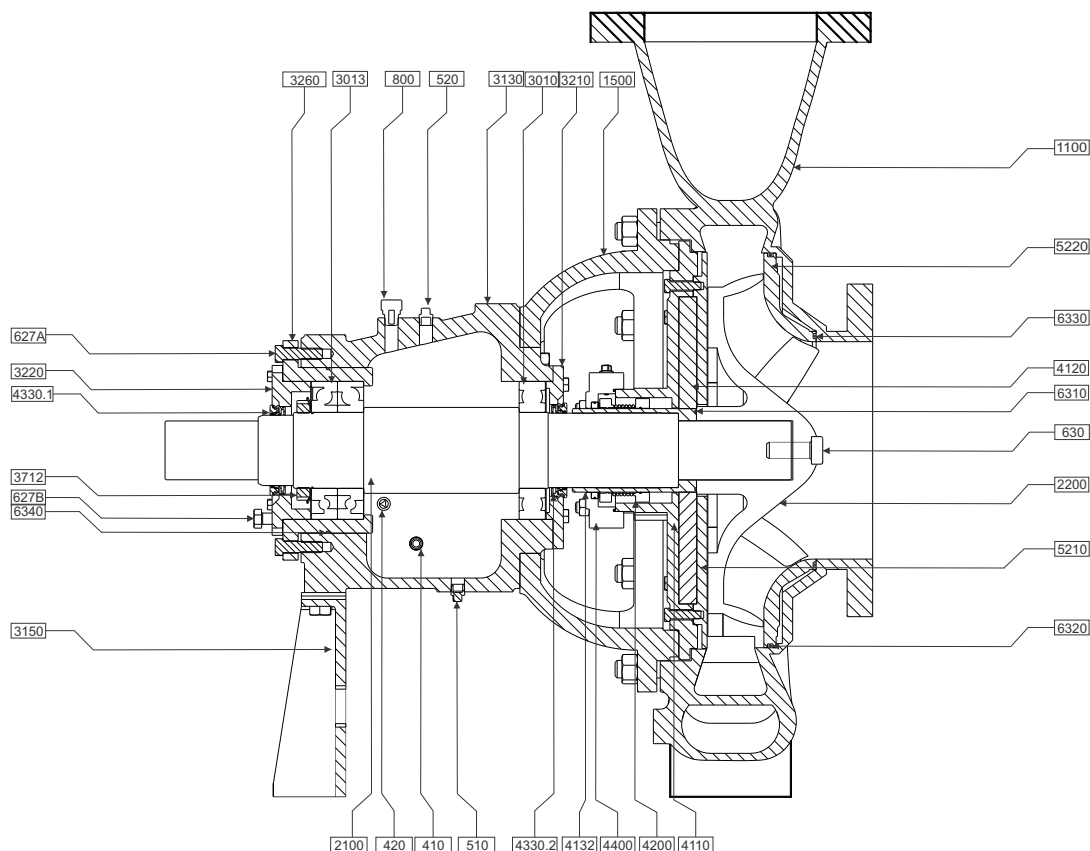

410	Ressuprimento de Óleo		
420	Visor de Óleo	3712	Porca de fixação do rolamento
510	Bujão dreno do mancal (Magnético)	4110	Caixa de Selagem
520	Bujão do mancal	4120	Expelidor
627A	Parafuso de ajuste Axial	4132	Luva protetora do Eixo
627B	Parafuso sacador	4200	Selo Mecânico
630	Parafuso fixação do Rotor	4330.1	Protetor de Mancal
800	Respiro de Ar (Vent do Mancal)	4330.2	Protetor de Mancal
1100	Voluta	4400	Sobreposta do Selo Mecânico
1500	Adaptador	4510	Anel Cadeado
2100	Eixo	4530	Gaxeta
2200	Rotor	4540	Aperta Gaxeta
3010	Rolamento Radial	4590	Retentor (opcional)
3013	Rolamento Axial	5210	Placa de Desgaste Traseira (opcional)
3130	Corpo do Mancal	5220	Placa de Desgaste Dianteira
3150	Base de apoio do Mancal	6310	Anel o-ring da Luva Protetora
3210	Tampa interna do Mancal	6320	Anel o-ring da Placa de Desgaste Dianteira
3220	Tampa externa do Mancal	6330	Anel o-ring da Placa de Desgaste Dianteira
3260	Caixa do rolamento Axial	6340	Anel o-ring da Caixa do Rolamento
REF.	DESCRIÇÃO	REF.	DESCRIÇÃO



MATERIAIS CONSTRUTIVOS

MATERIAIS CONSTRUTIVOS				
Número do Item	Nome da Peça	MATERIAL		
		FERRO NODULAR	316SS	CD4MCu
510	Bujão dreno do mancal (Magnético)	AISI 304 / AISI 316		
520	Bujão do mancal	AISI 304 / AISI 316		
627A	Parafuso de ajuste Axial	Aço Carbono	AISI 316 / AISI 304	
627B	Parafuso sacador	Aço Carbono	AISI 316 / AISI 304	
630	Parafuso fixação do Rotor	AISI 316		
800	Respiro de Ar (Vent do Mancal)	Aço		
1100	Voluta	Ferro Fundido	AISI 316	CD4MCu
1500	Adaptador	Ferro Fundido		
2100	Eixo	AISI 4140	AISI 316	AISI 4140
2200	Rotor	AISI 316		CD4MCu
3010	Rolamento Radial	Aço Carbono		
3013	Rolamento Axial	Aço Carbono		
3130	Corpo do Mancal	Ferro Fundido		
3150	Base de apoio do Mancal	Ferro Fundido		
3210	Tampa interna do Mancal	Ferro Fundido		
3220	Tampa externa do Mancal	Ferro Fundido		
3260	Caixa do rolamento Axial	Ferro Fundido		
3712	Porca de fixação do rolamento	Aço Carbono		
4110	Caixa de Selagem	Ferro Fundido	AISI 316	CD4MCu
4120	Expelidor	Ferro Fundido	AISI 316	CD4MCu
4132	Luva Protetora do Eixo	AISI 316 (revestimento opcional)		AISI 316
4200	Selo Mecânico	Vários		
4330.1	Protetor de Mancal	Bronze		
4330.2	Protetor de Mancal	Bronze		
4400	Sobreposta do Selo Mecânico	AISI 316		
4510	Anel Cadeado	Bronze		
4520	Bucha de Fundo (Bucha de Garganta)	Aço	AISI 316	CD4MCu
4530	Gaxeta	PTFE / EPDM		
4540	Aperta Gaxeta	Ferro Fundido	316SS	
4590	Retentor (Opcional)	NBR		
5210	Placa de Desgaste Traseira	AISI 316		CD4MCu
5220	Placa de Desgaste Dianteira	AISI 316		CD4MCu
6310	Anel o-ring da Luva Protetora	VITON®		
6320	Anel o-ring da Placa de Desgaste Dianteira	VITON®		
6330	Anel o-ring da Placa de Desgaste Dianteira	VITON® / BUNA-N		
6340	Anel o-ring da caixa do rolamento	VITON® / BUNA-N		



PRINCIPAIS DIMENSÕES

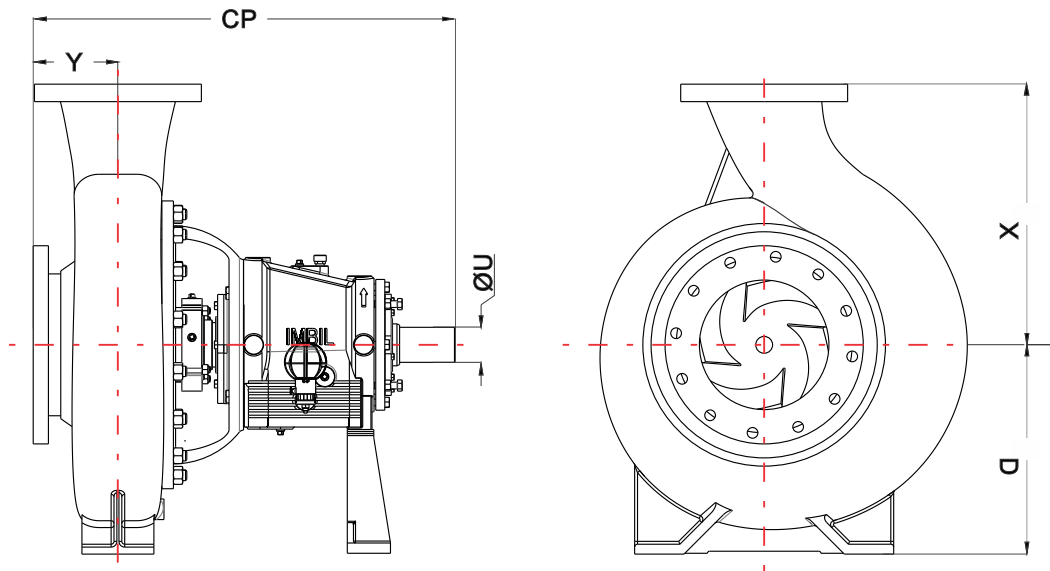

TAMANHO	SUCÇÃO	DESCARGA	DIMENSÕES DA BOMBA [mm]					
			CP	D	X	Y	ØU	
3X6X14	152 (6")	25 (3")	1010 (39 3/4")	318 (12 1/2")	330 (13")	184 (7 1/4")	47,63 (1.875") 47,60 (1.874")	
4X6X14	152 (6")	100 (4")			368 (14 1/2")			
4X6X18	152 (6")	100 (4")			406 (16")			
6X8X14	203 (8")	152 (6")	1010 (39 3/4")	368 (14 1/2")	406 (16")	184 (7 1/4")		
6X8X18	203 (8")	152 (6")			457 (18")			
6X8X22	203 (8")	152 (6")	1010 (39 3/4")	432 (17")	533 (21")	184 (7 1/4")	60,33 (2.375") 60,30 (2.374")	
8X10X14	254 (10")	203 (8")	1045 (41 3/4")	368 (14 1/2")	483 (19")	206 (8 1/4")		
8X10X18	254 (10")	203 (8")			533 (21")			
8X10X18H	254 (10")	203 (8")			432 (17")			533 (21")
8X10X22	254 (10")	203 (8")			432 (17")			584 (23")
10X12X18	305 (12")	254 (10")	1045 (41 3/4")	508 (20")	584 (23")	206 (8 1/4")	85,73 (3.375") 85,70 (3.374")	
10X12X22	305 (12")	254 (10")			635 (25")			
12X14X18	355 (14")	305 (12")	1080 (42 1/2")	508 (20")	635 (25")	225 (8 3/4")		
12X14X22	355 (14")	305 (12")			686 (27")			
14X14X18	355 (14")	355 (14")			686 (27")			
14X14X22	355 (14")	355 (14")			559 (22")			762 (30")
18X18X22	457 (18")	457 (18")	1105 (43 3/4")	711 (28")	864 (34")	251 (9 3/4")		

() Dimensões em polegadas

Bombas BMS

Processos de
Papel & Celulose



INTERCAMBIALIDADE ENTRE AS BOMBAS

Uma vantagem do projeto das bombas da linha BMS é a intercambiabilidade modular, ou seja, existem varias peças que são comuns em vários tamanhos de bombas. Portanto quando o usuário tem vários tamanhos de bomba operando, o estoque de peças de reposição é reduzido, pois uma mesma peça serve para varios tamanhos. Na tabela a seguir apresentamos a intercambiabilidade de peças entre os diversos tamanhos:

MANCAL 01	ADAPTADOR	CAIXA DE SELAGEM	ROTOR	VOLUTA	TAMANHO
					BMS 3X6X14
					BMS 4X6X14
					BMS 6X8X14
					BMS 4X6X18

MANCAL 03	ADAPTADOR	CAIXA DE SELAGEM	ROTOR	VOLUTA	TAMANHO
					BMS 12X14X18
					BMS 14X14X18
					BMS 10X12X22
					BMS 12X14X22
					BMS 14X14X22
					BMS 18X18X22

MANCAL 02	ADAPTADOR	CAIXA DE SELAGEM	ROTOR	VOLUTA	TAMANHO
					BMS 6X8X22
					BMS 8X10X22
					BMS 8X10X14
					BMS 6X8X18
					BMS 8X10X18
					BMS 8X10X18 H
					BMS 10X12X18
					BMS 10X12X18



BMS 3X6X14

1780 RPM

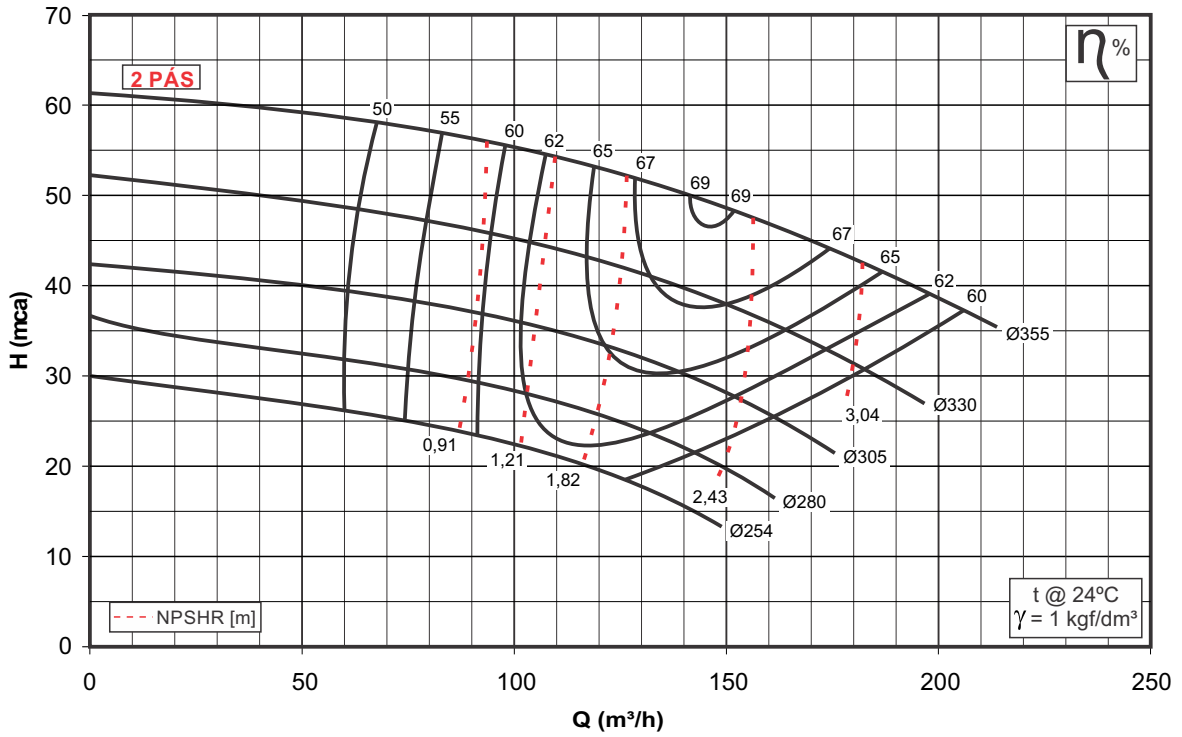

BMS 3X6X14

1780 RPM

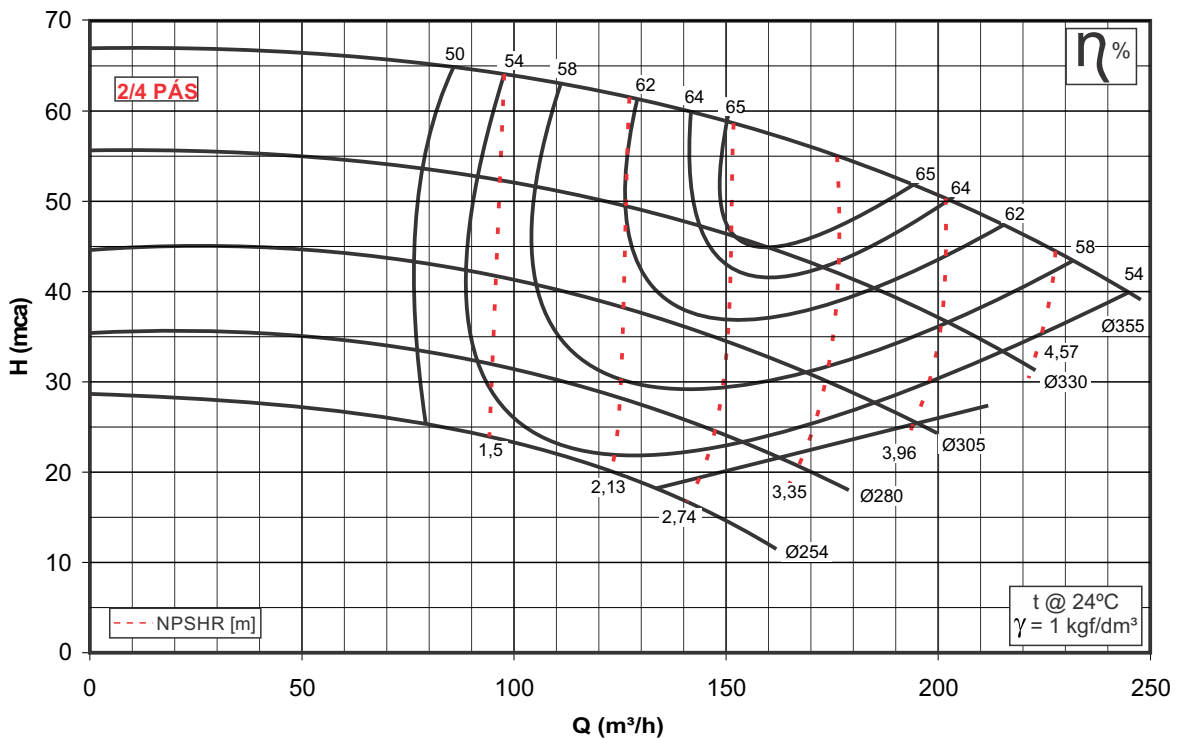

BMS 3X6X14

1780 RPM

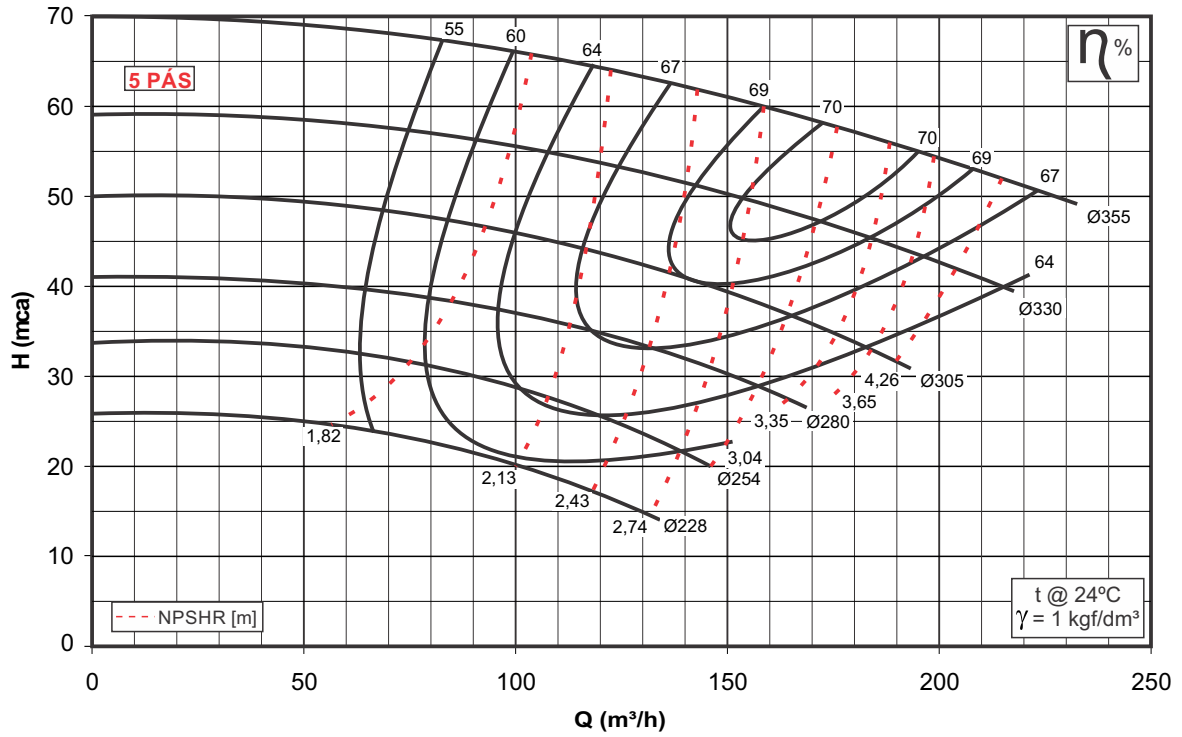

BMS 4X6X14

1780 RPM

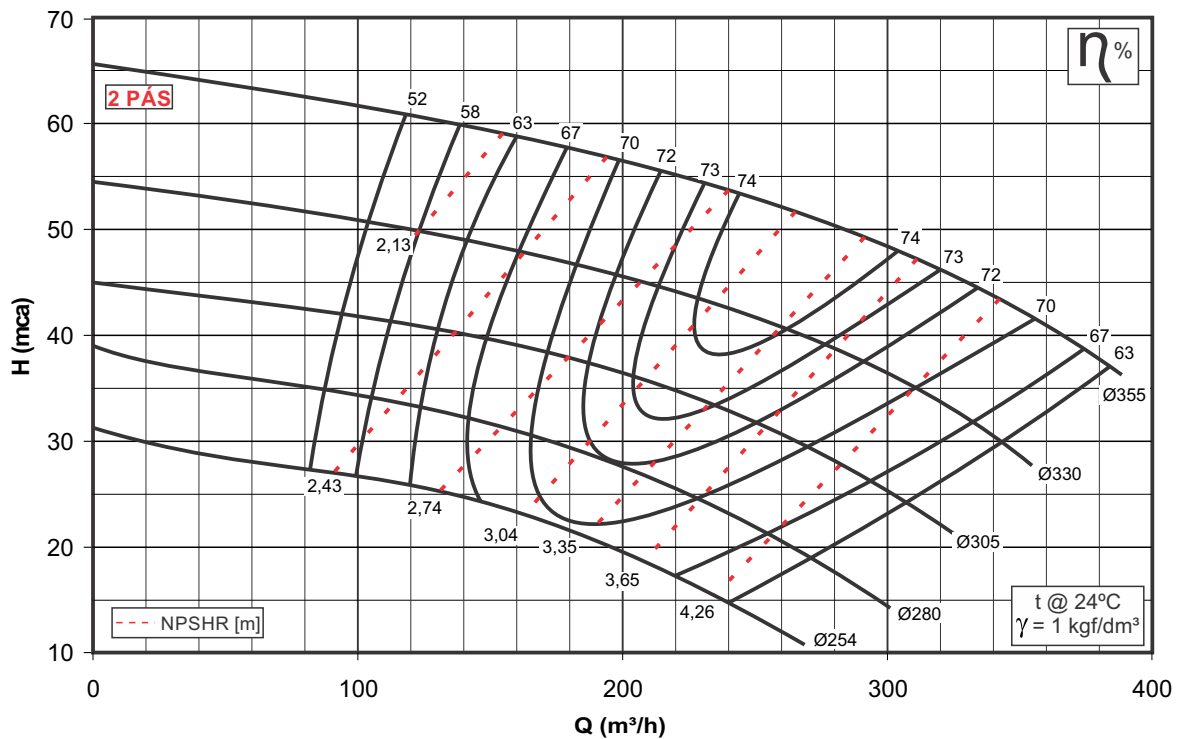



BMS 4X6X14

1780 RPM

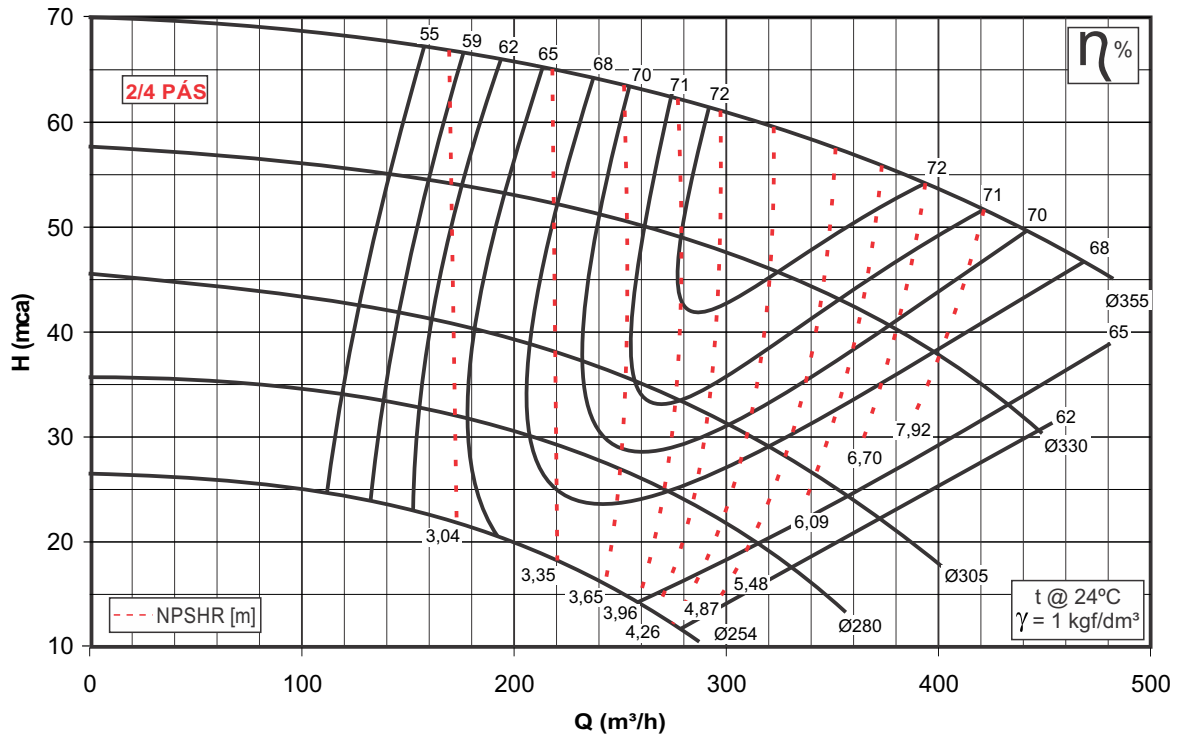

BMS 4X6X14

1780 RPM

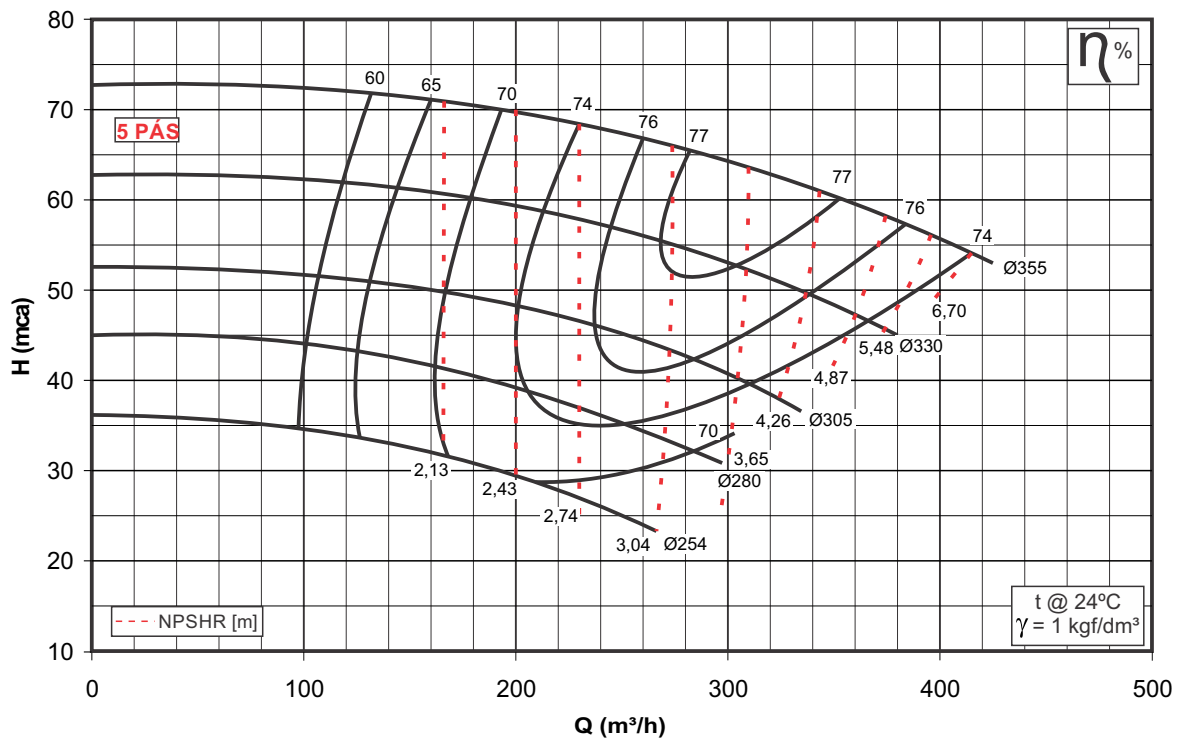



BMS 4X6X18

1780 RPM

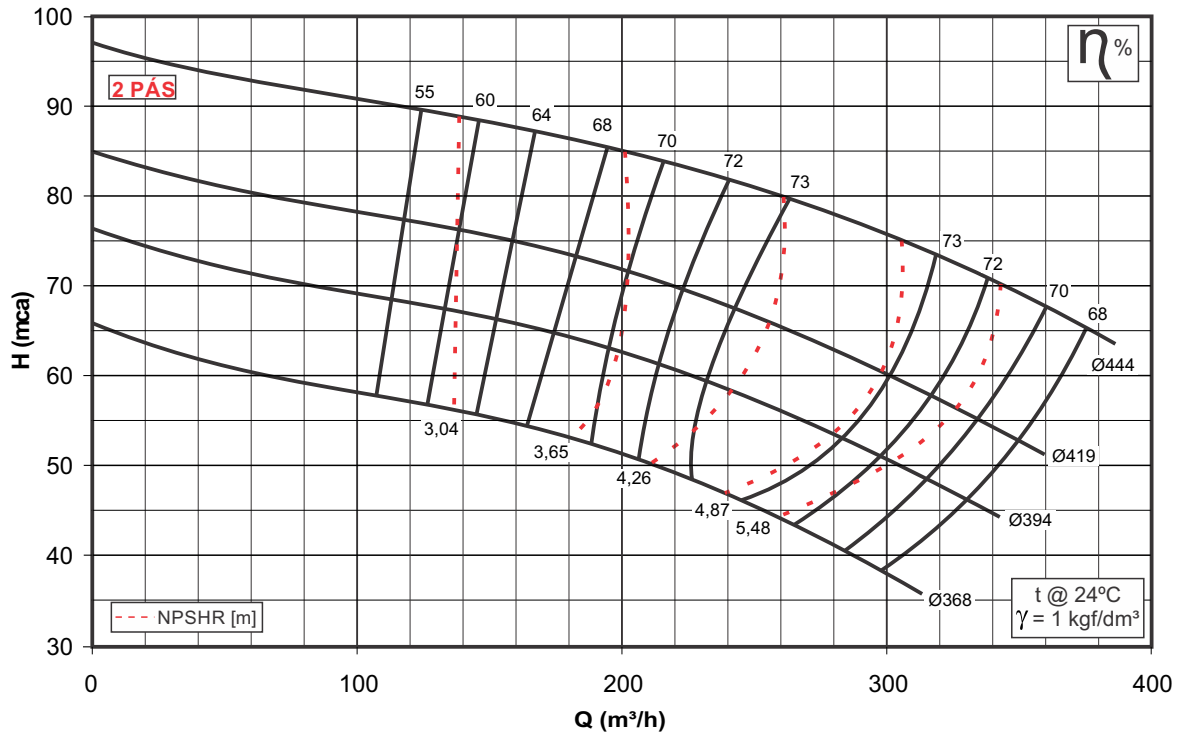

BMS 4X6X18

1780 RPM

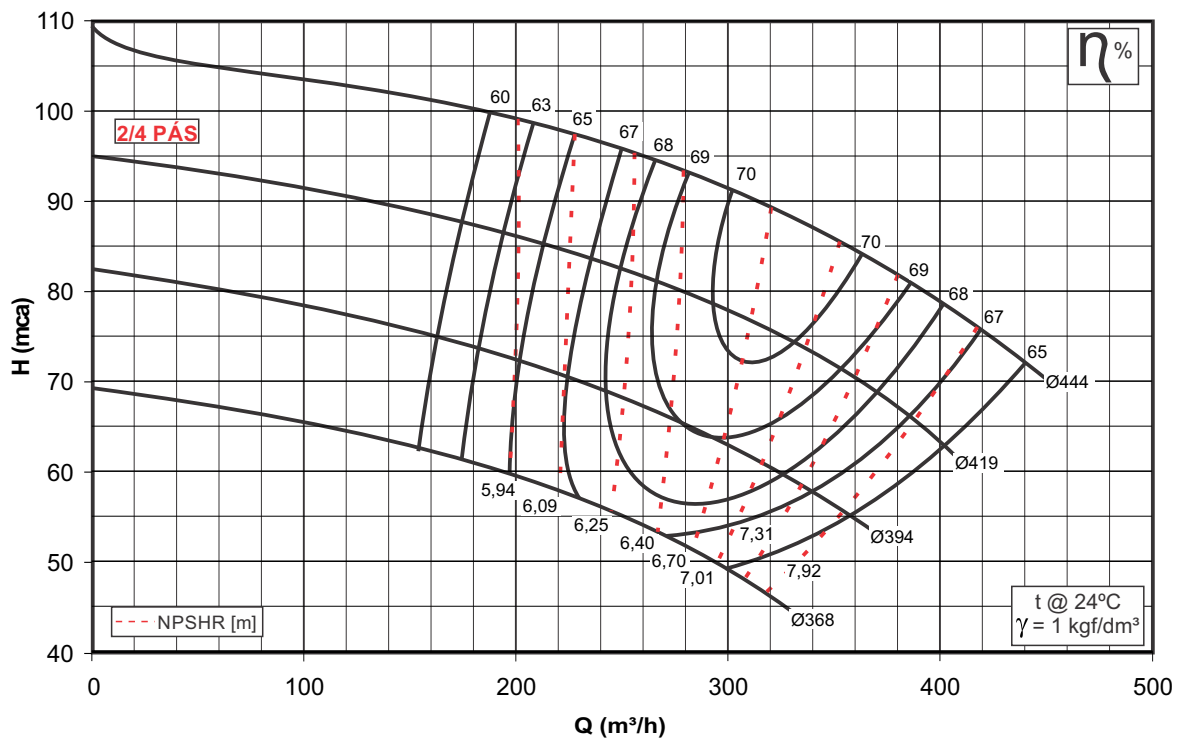

BMS 6X8X14

1780 RPM

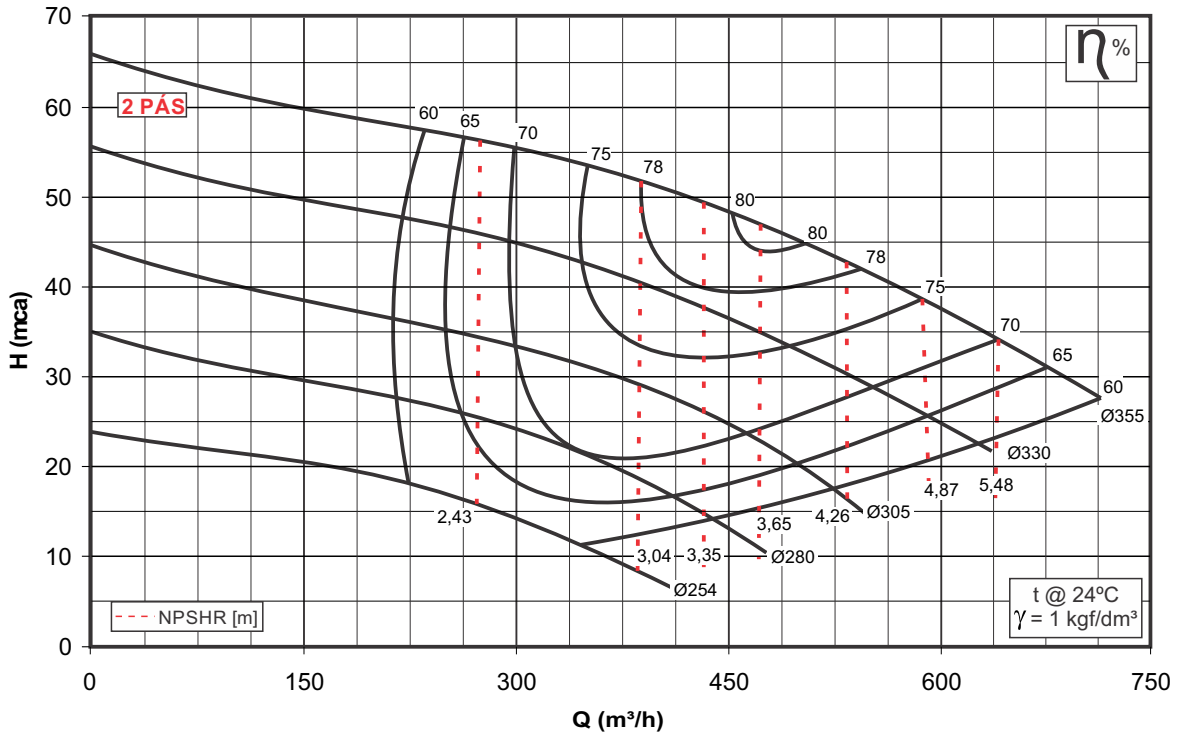

BMS 6X8X14

1780 RPM

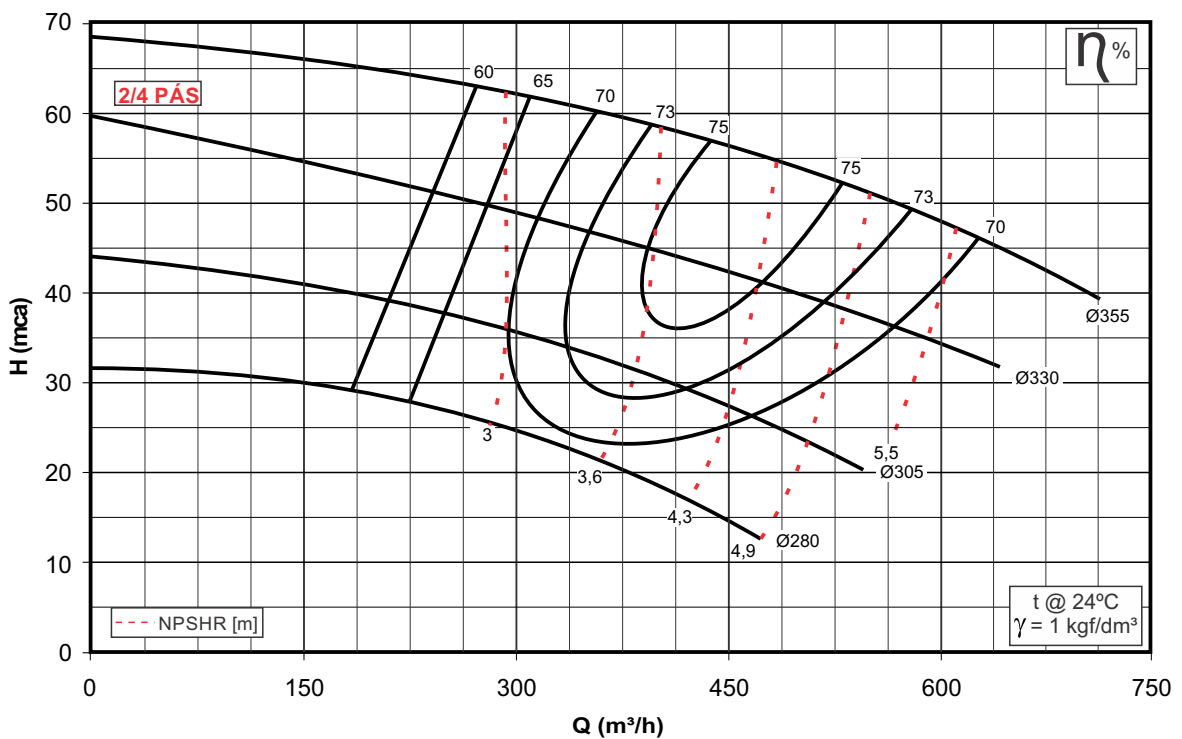



BMS 6X8X18

1780 RPM

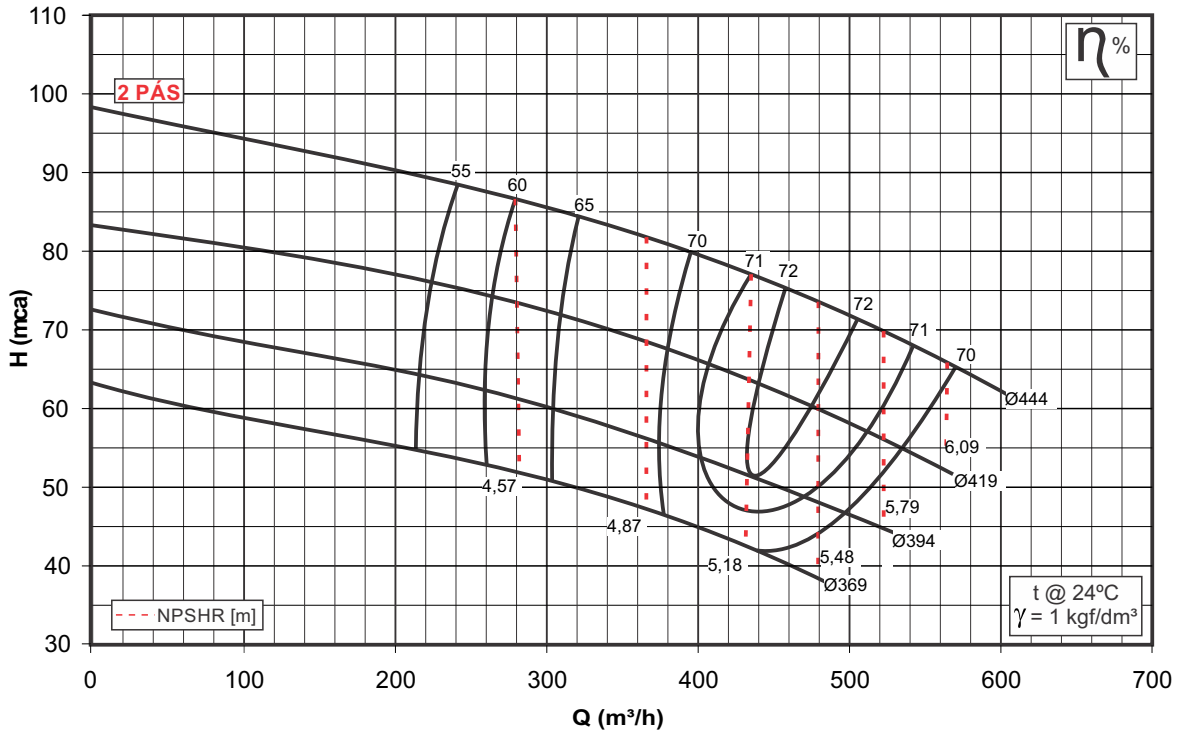

BMS 6X8X18

1780 RPM

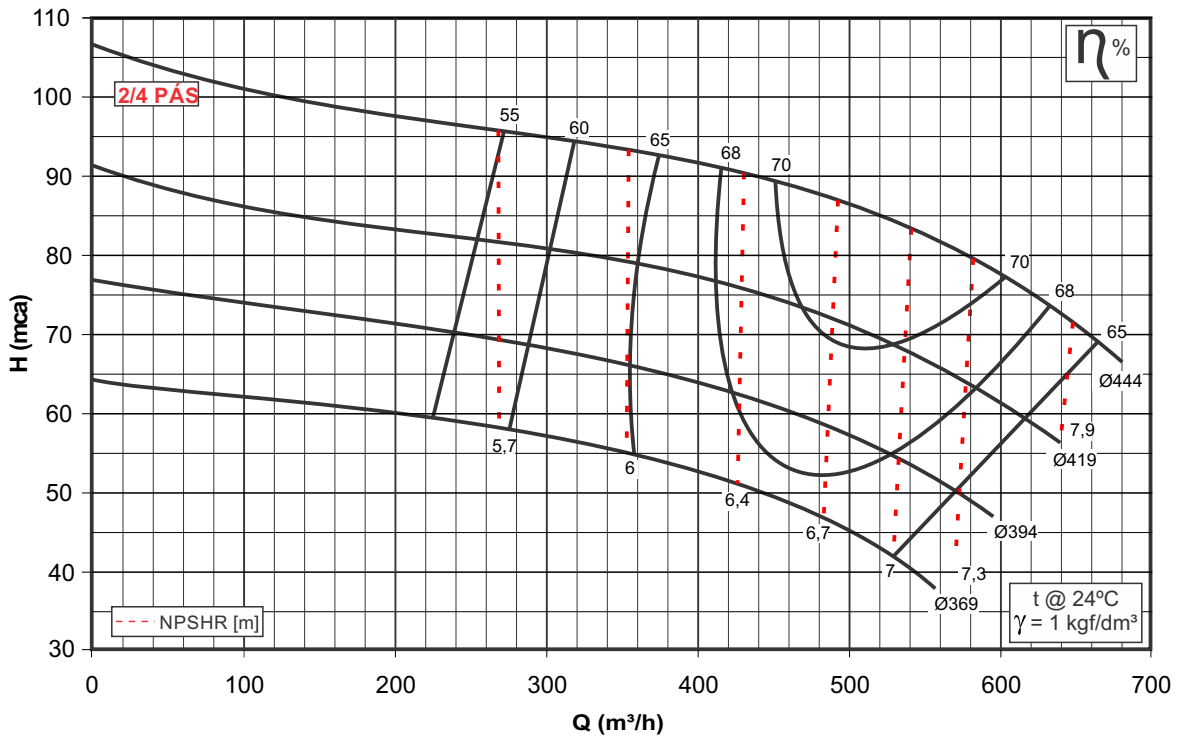



BMS 6X8X18

1780 RPM

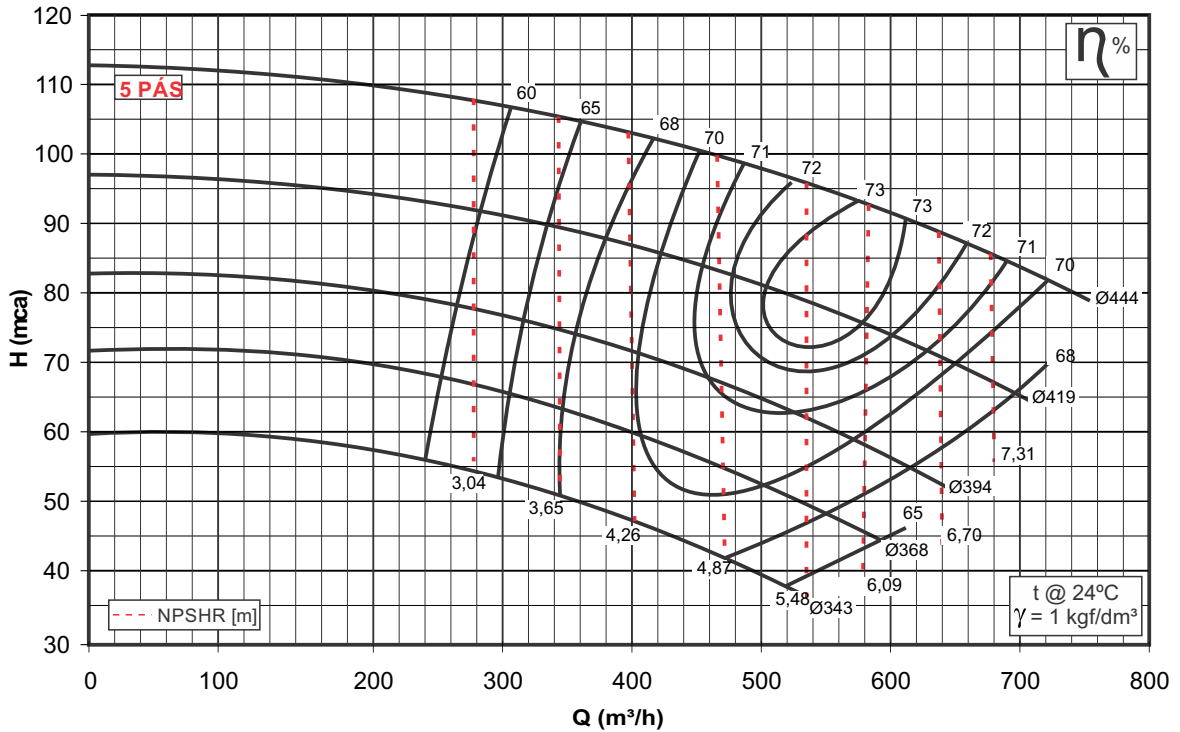

BMS 8X10X14

1780 RPM

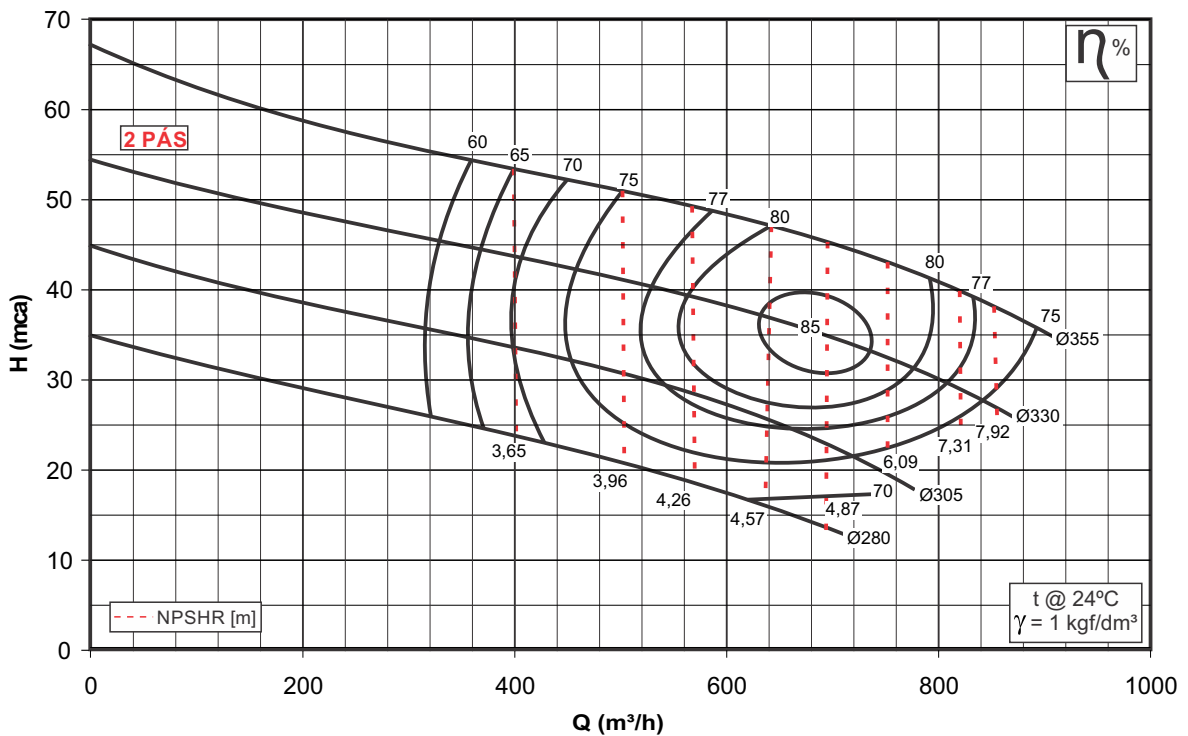



BMS 8X10X18

1780 RPM

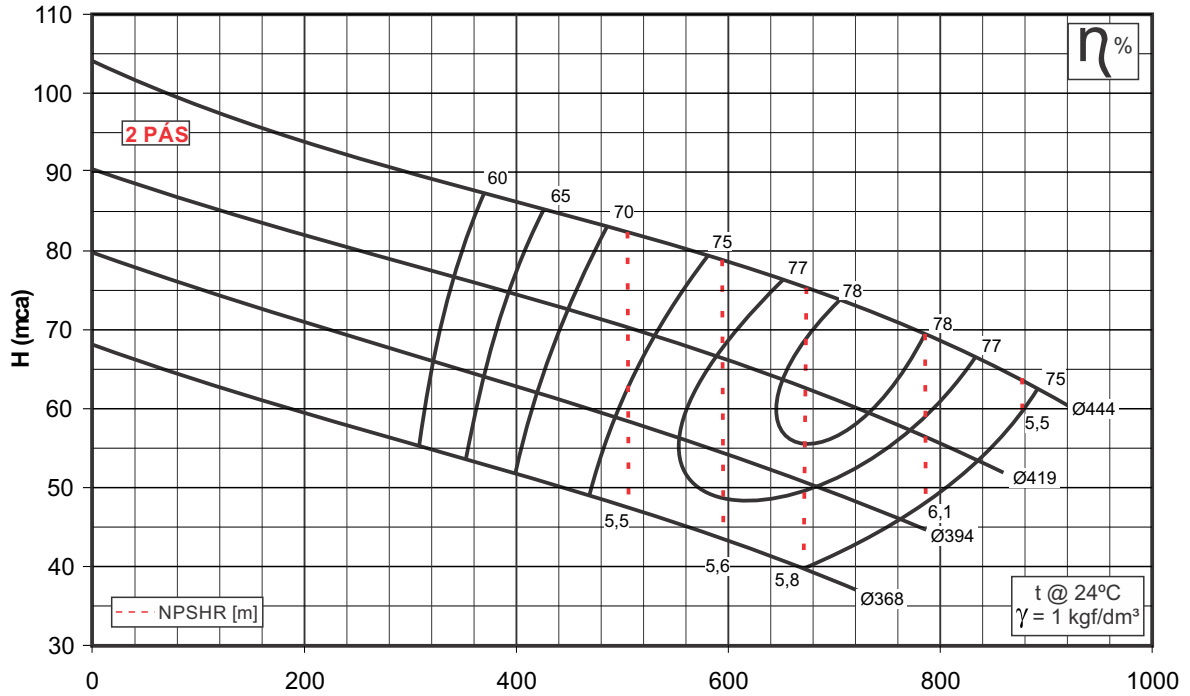

BMS 8X10X18

1780 RPM

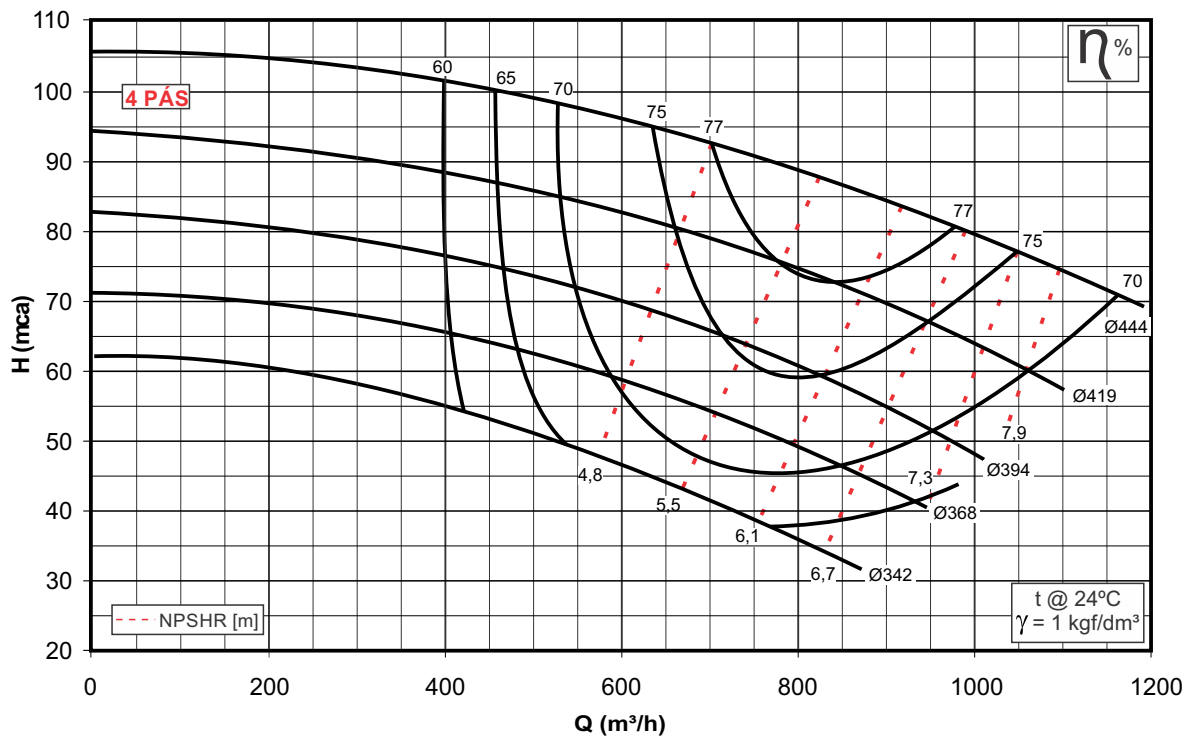



BMS 3X6X14

1180 RPM

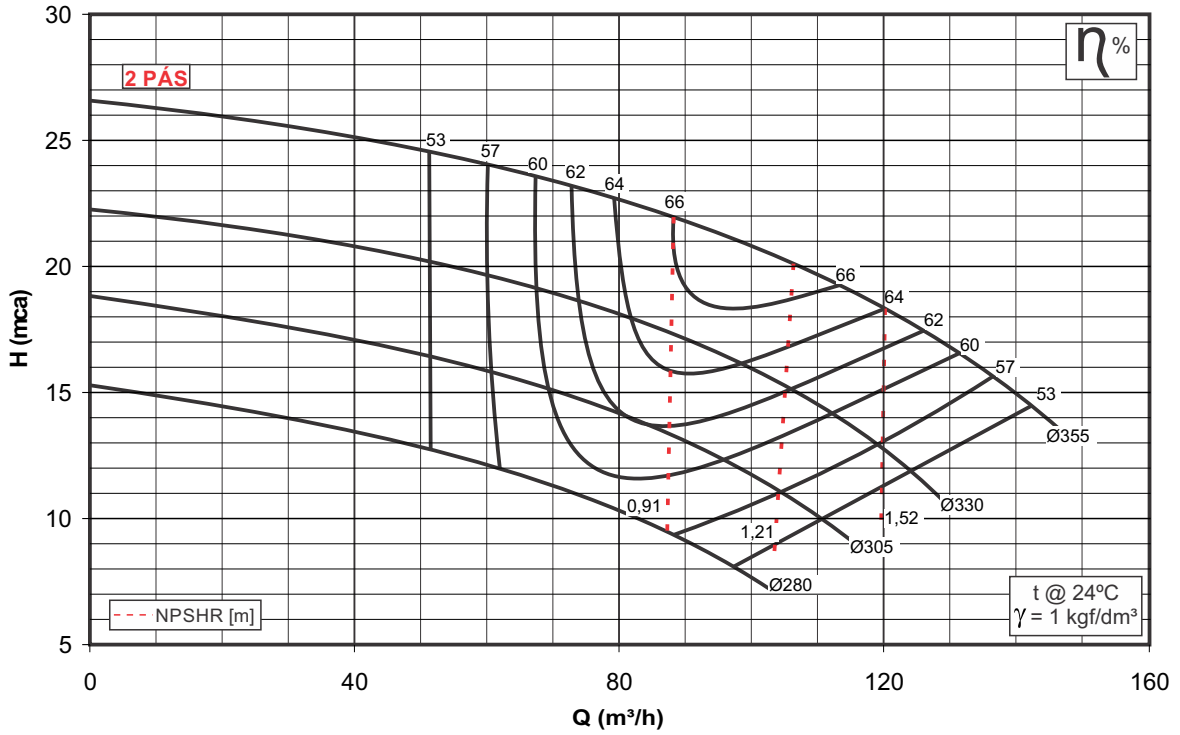

BMS 3X6X14

1180 RPM

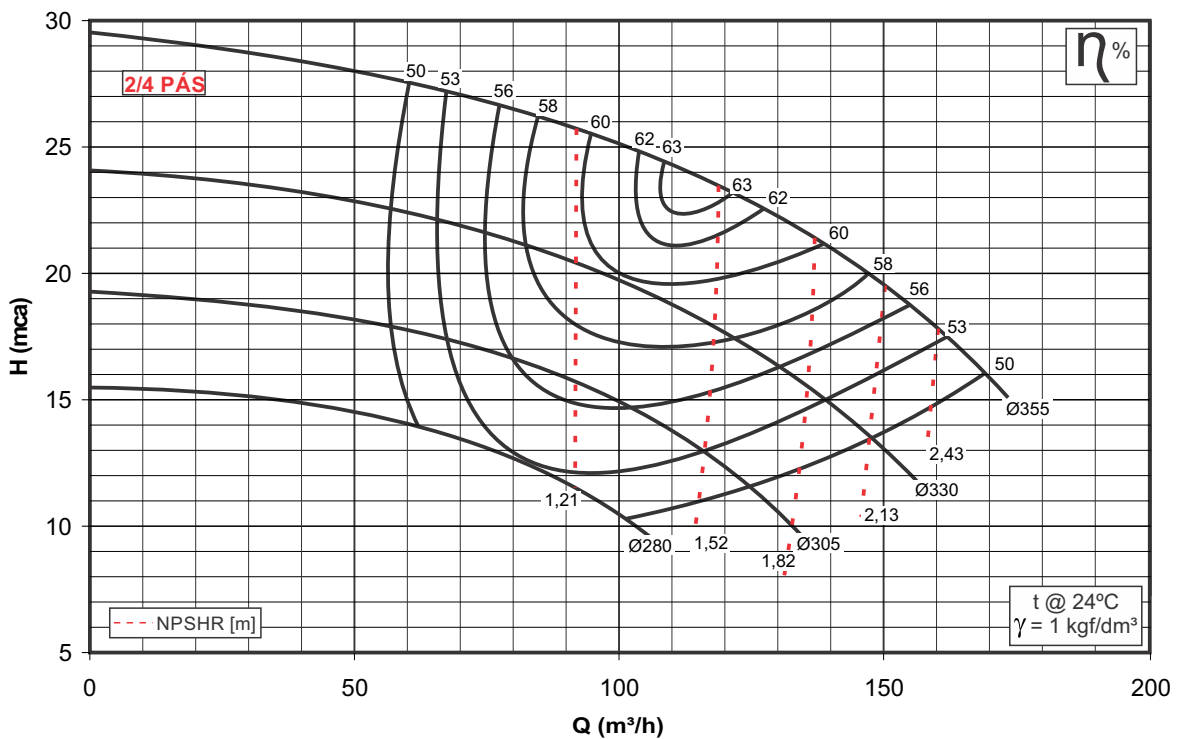



BMS 4X6X14

1180 RPM

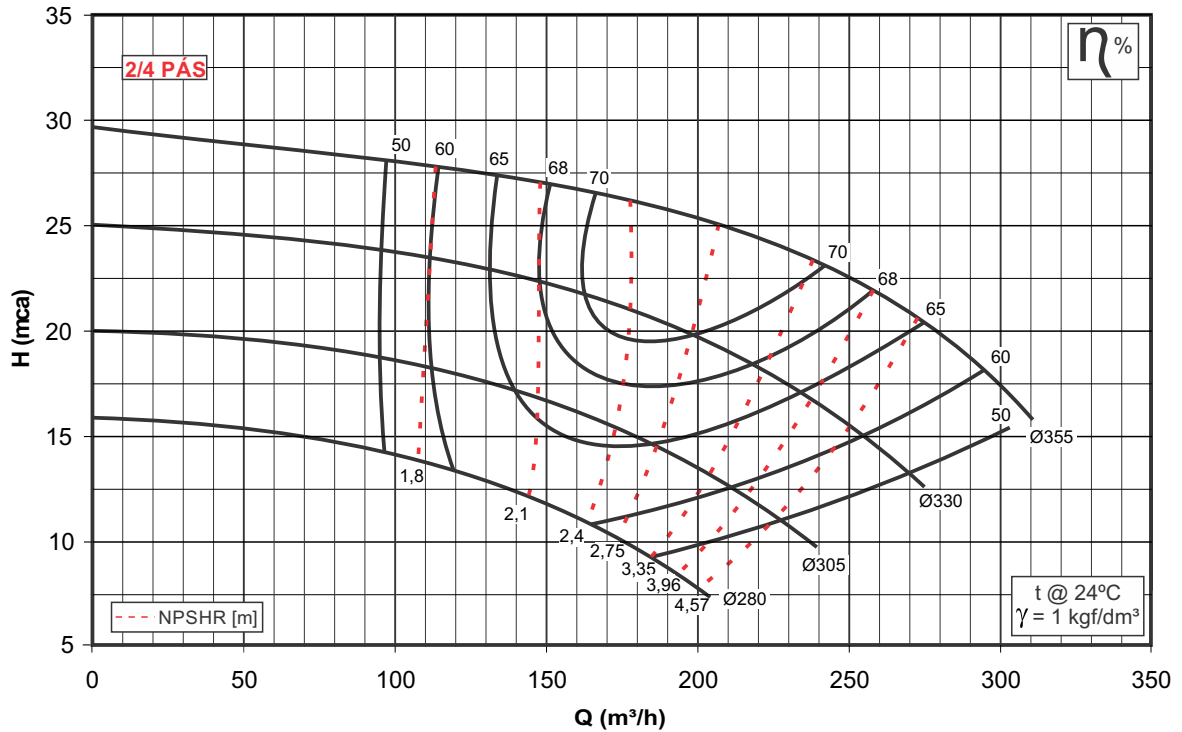

BMS 4X6X14

1180 RPM

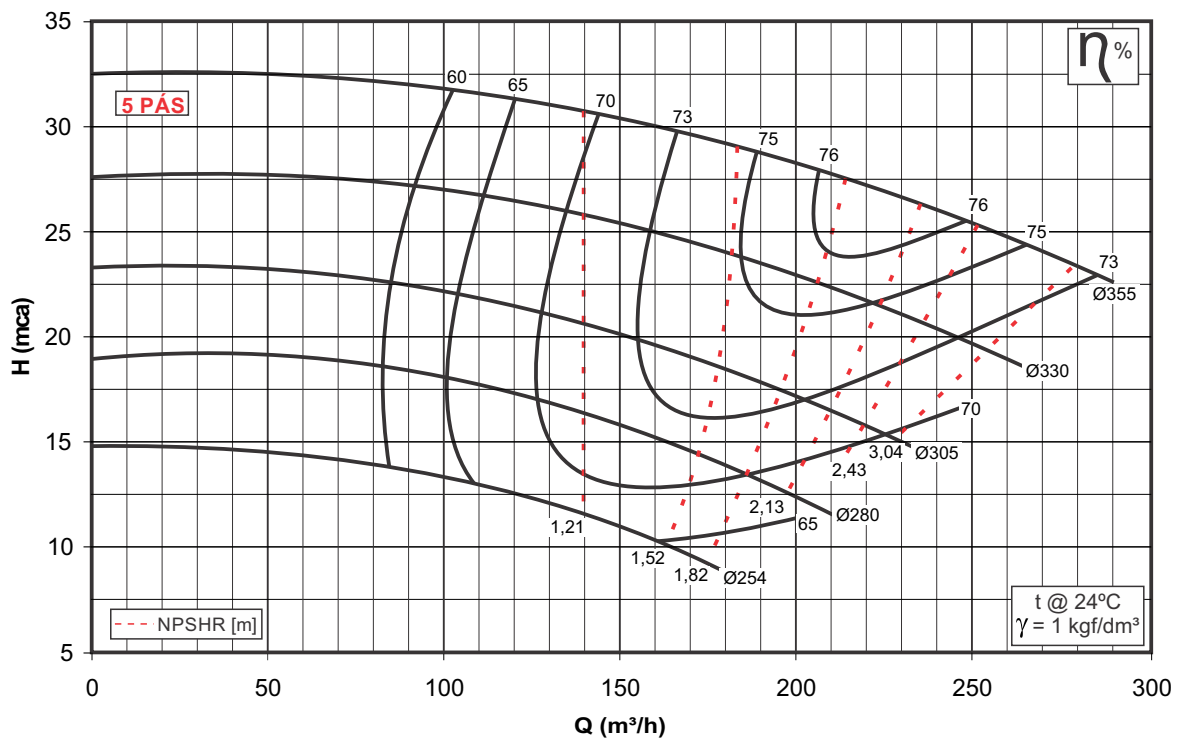



BMS 4X6X18

1180 RPM

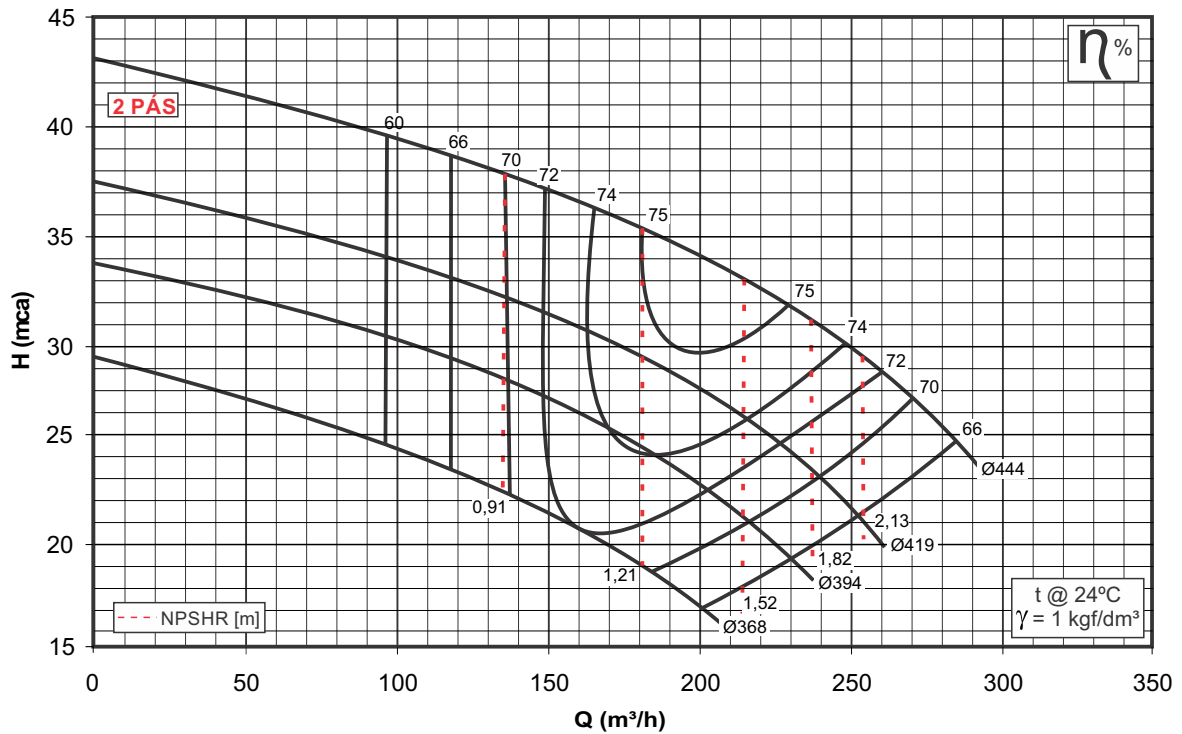

BMS 4X6X18

1180 RPM

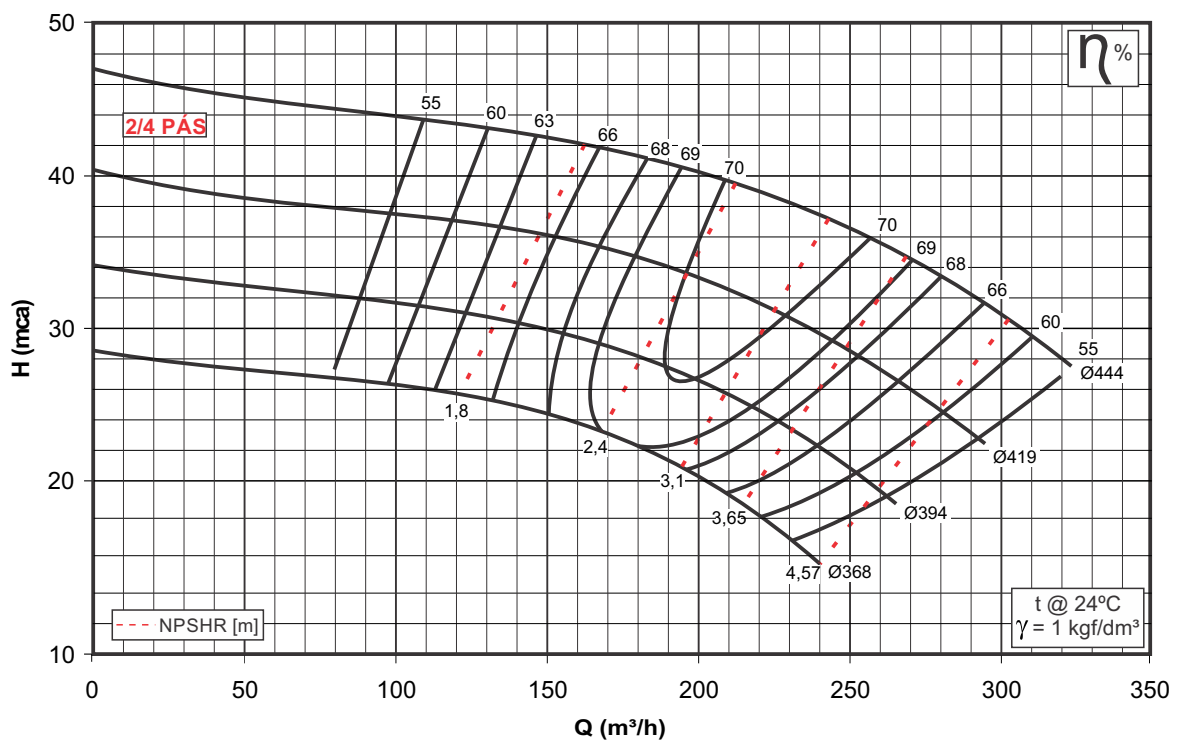



BMS 6X8X14

1180 RPM

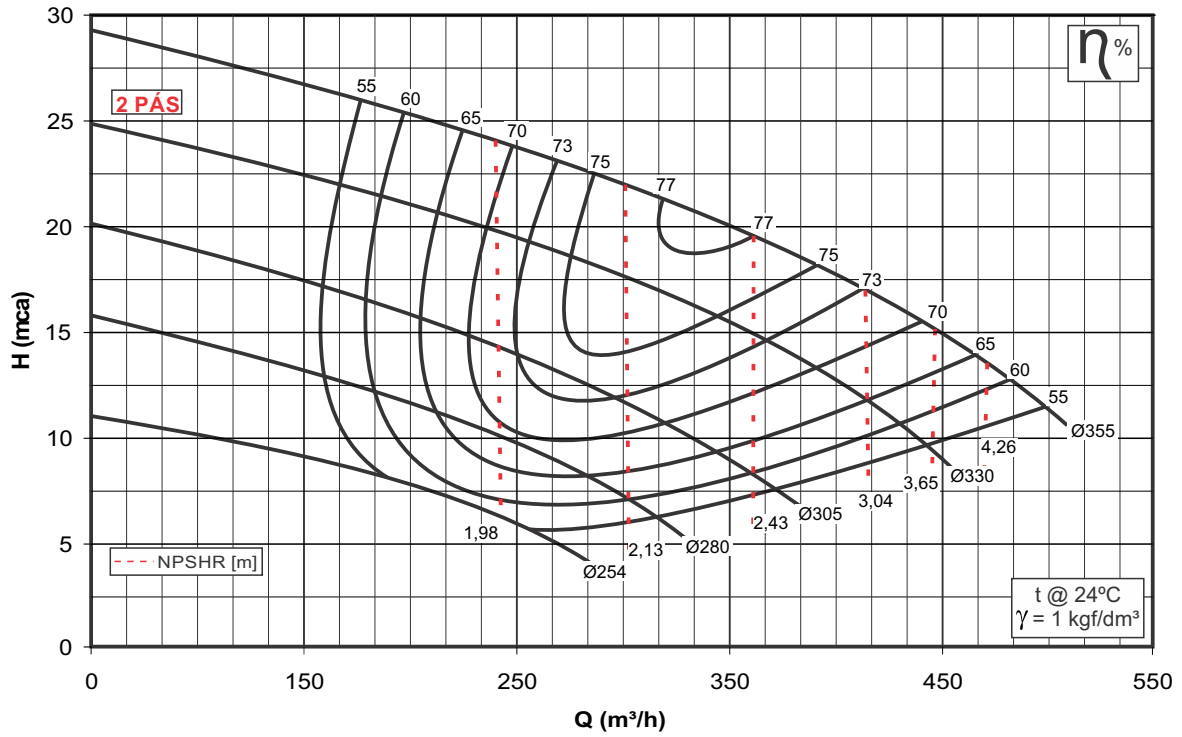

BMS 6X8X14

1180 RPM

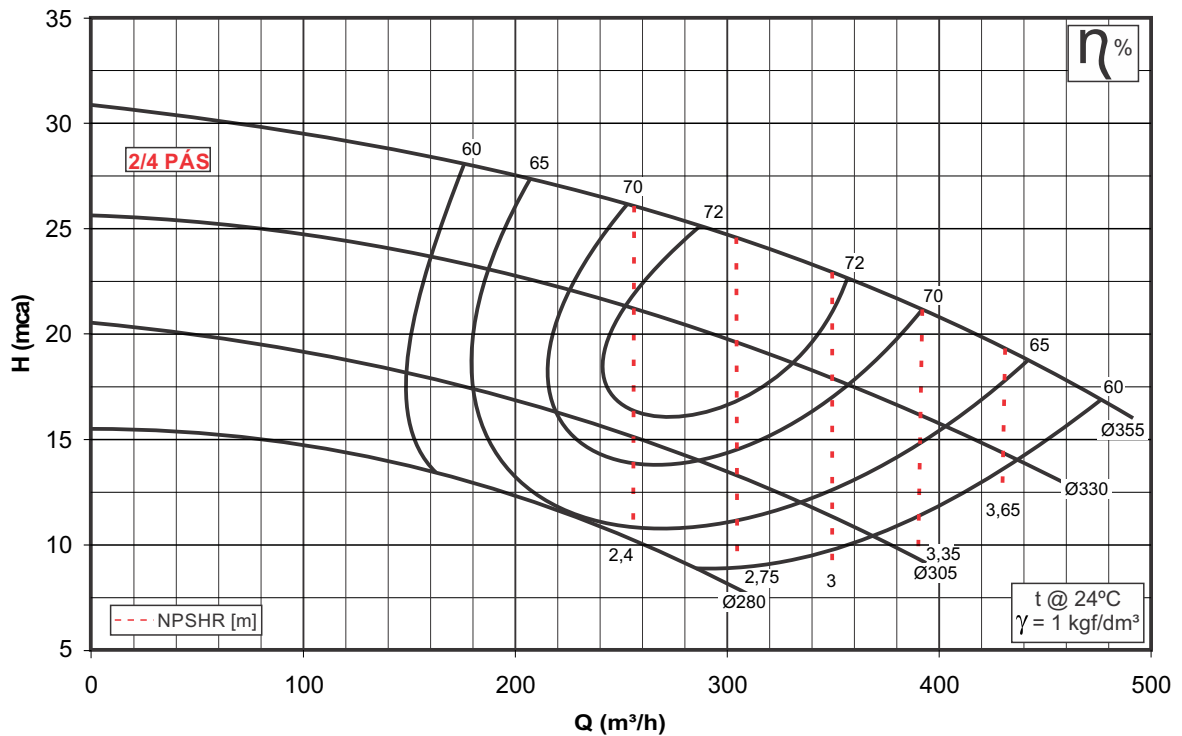



BMS 6X8X18

1180 RPM

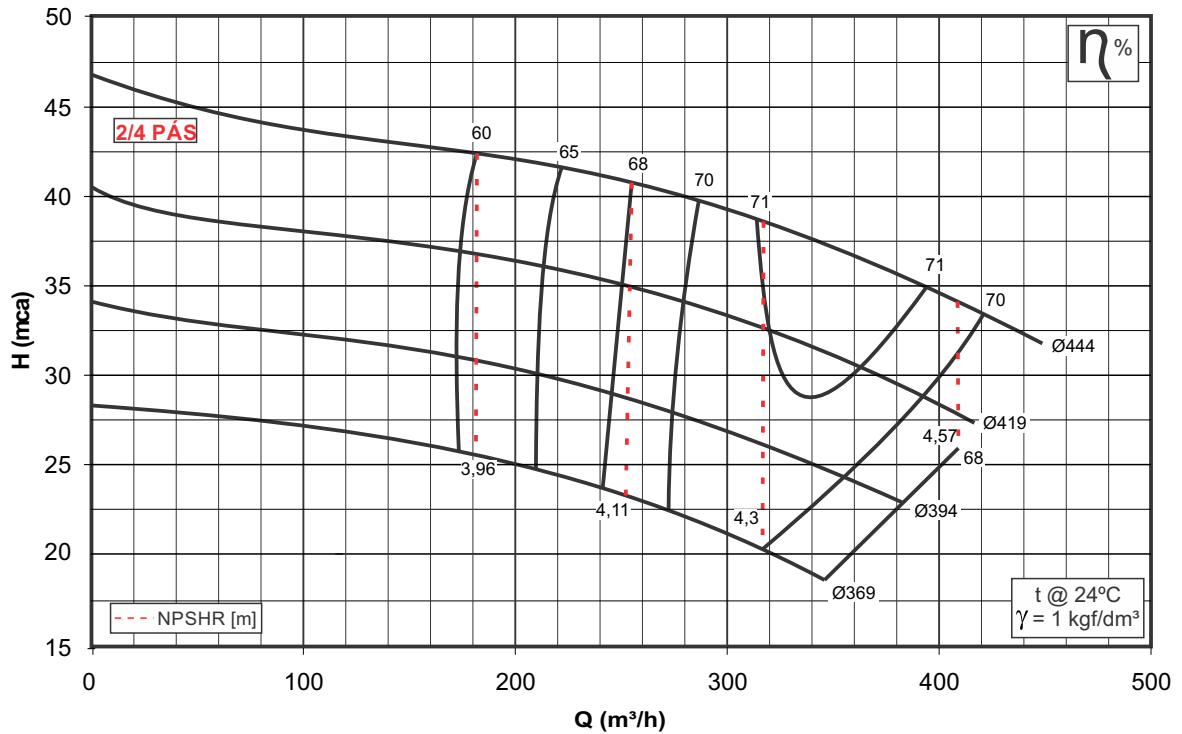

BMS 6X8X18

1180 RPM

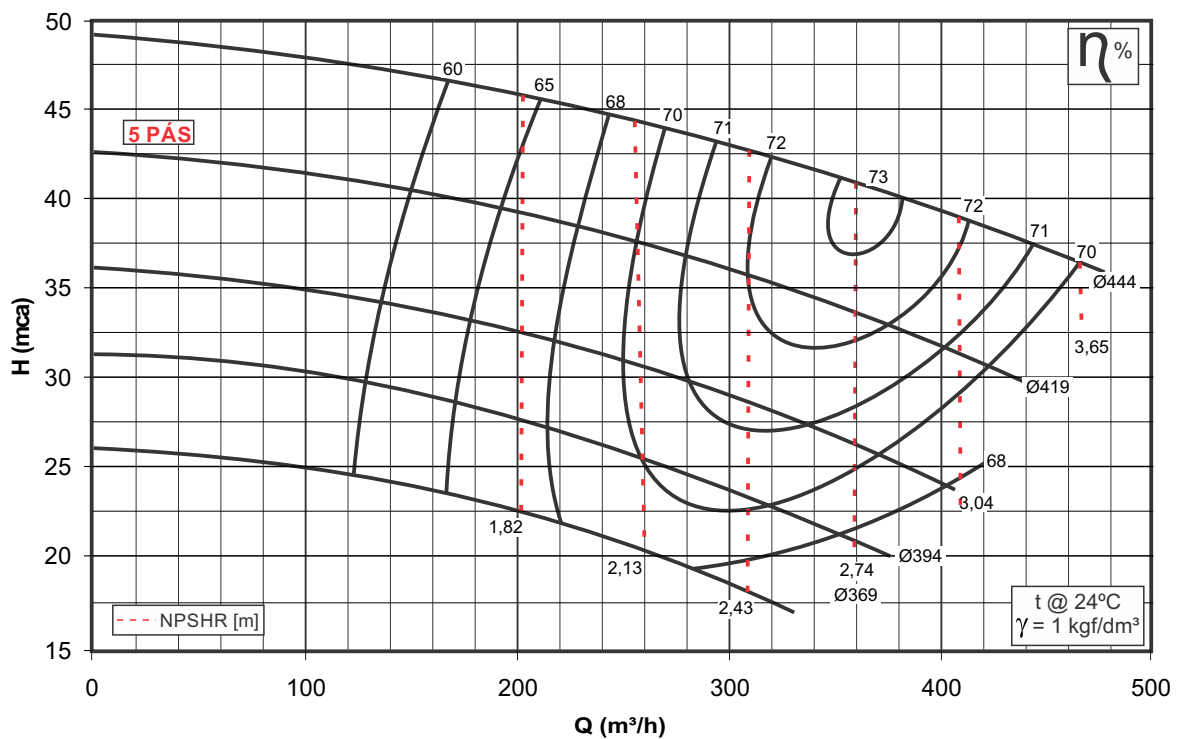



BMS 6X8X22

1180 RPM

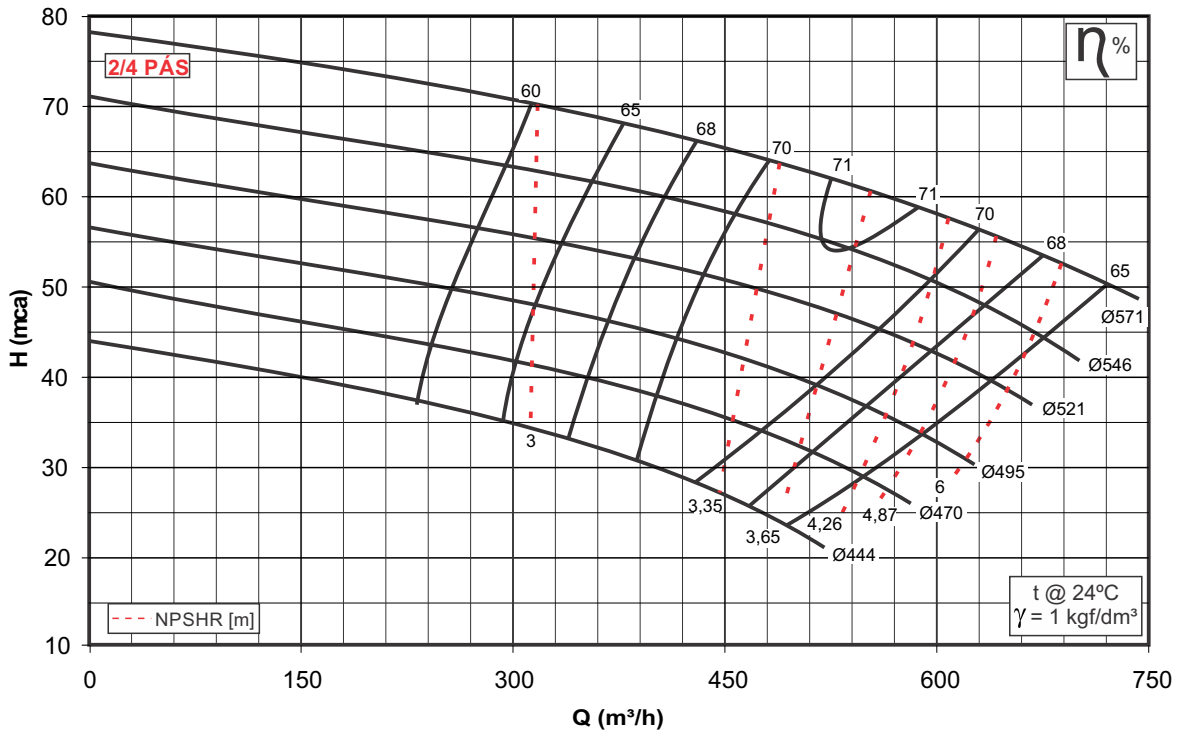

BMS 6X8X22

1180 RPM

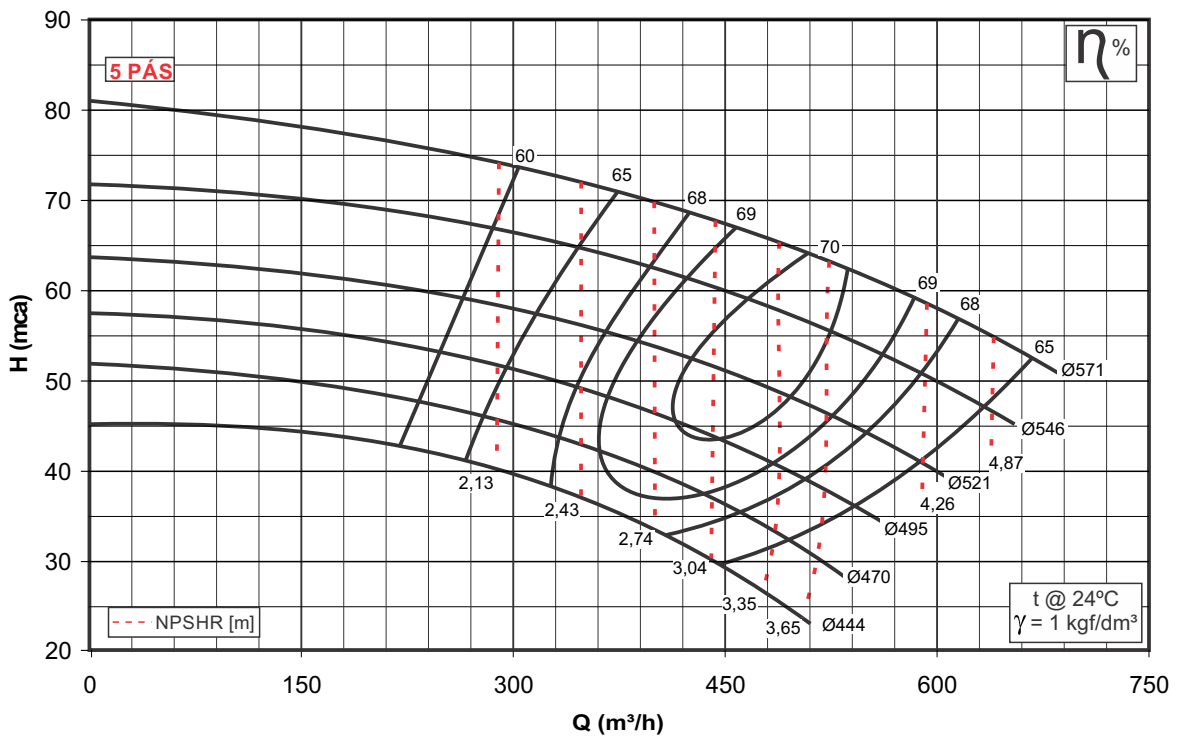



BMS 8X10X14

1180 RPM

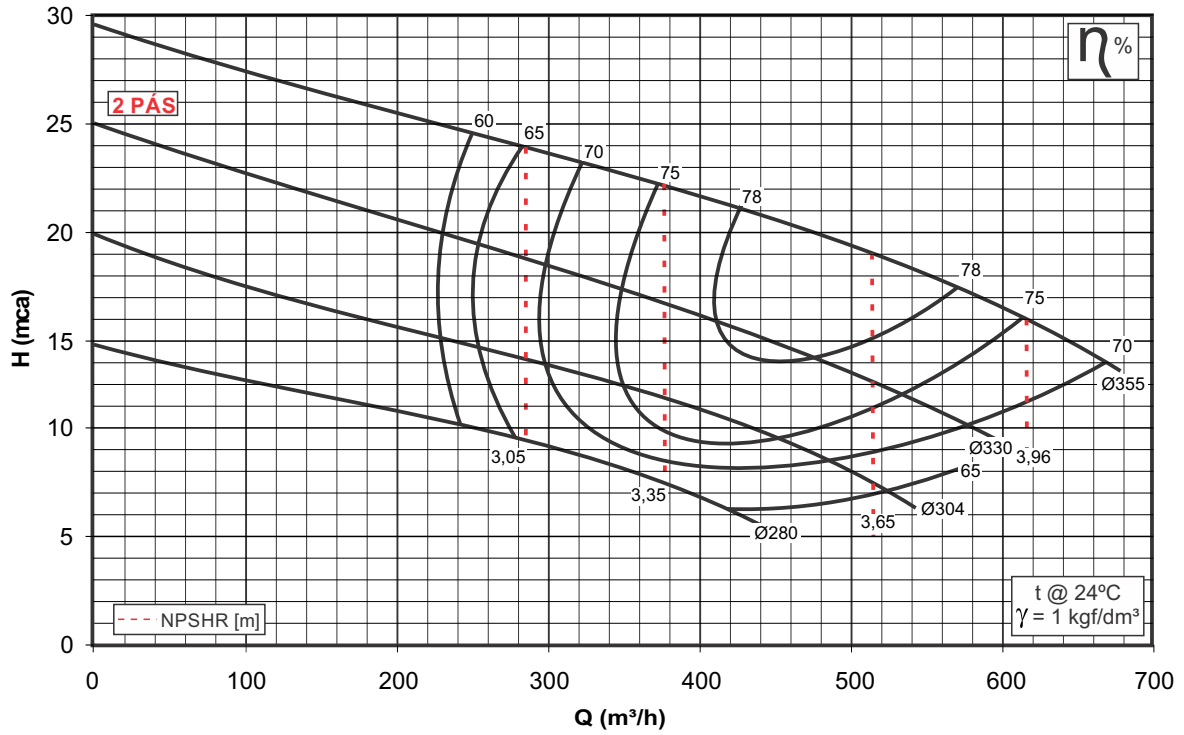

BMS 8X10X18

1180 RPM

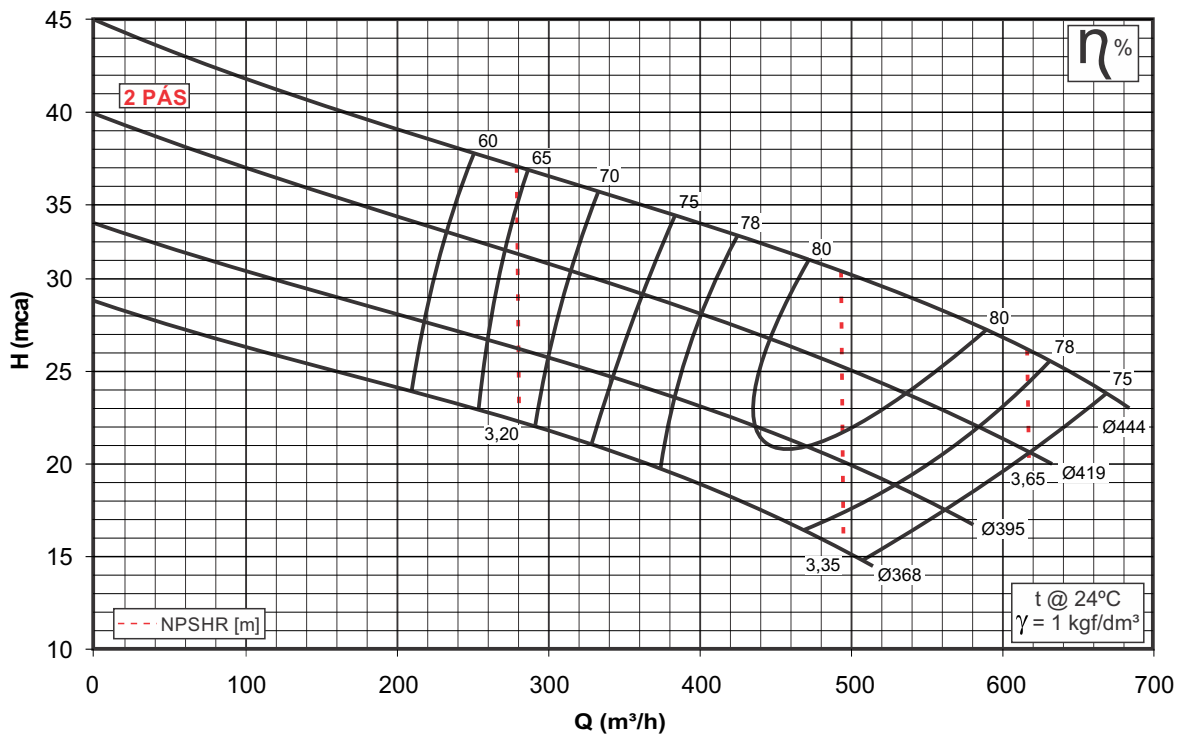



BMS 8X10X18

1180 RPM

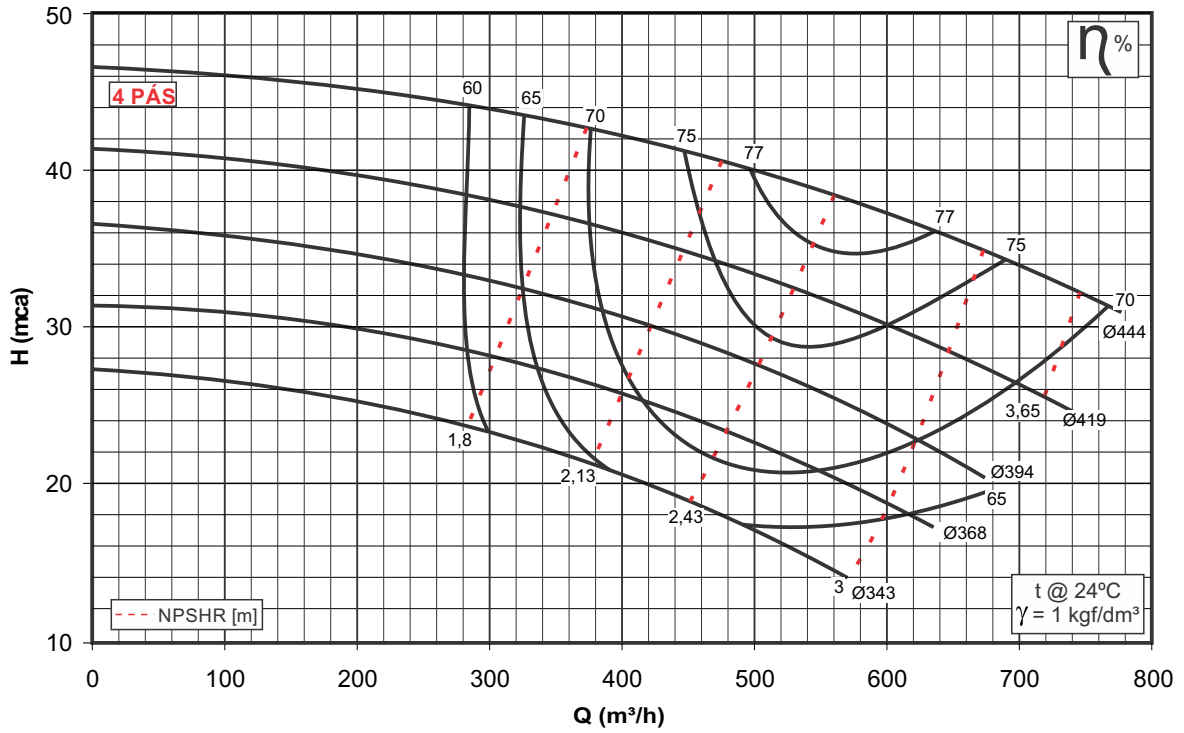

BMS 8X10X18 H

1180 RPM

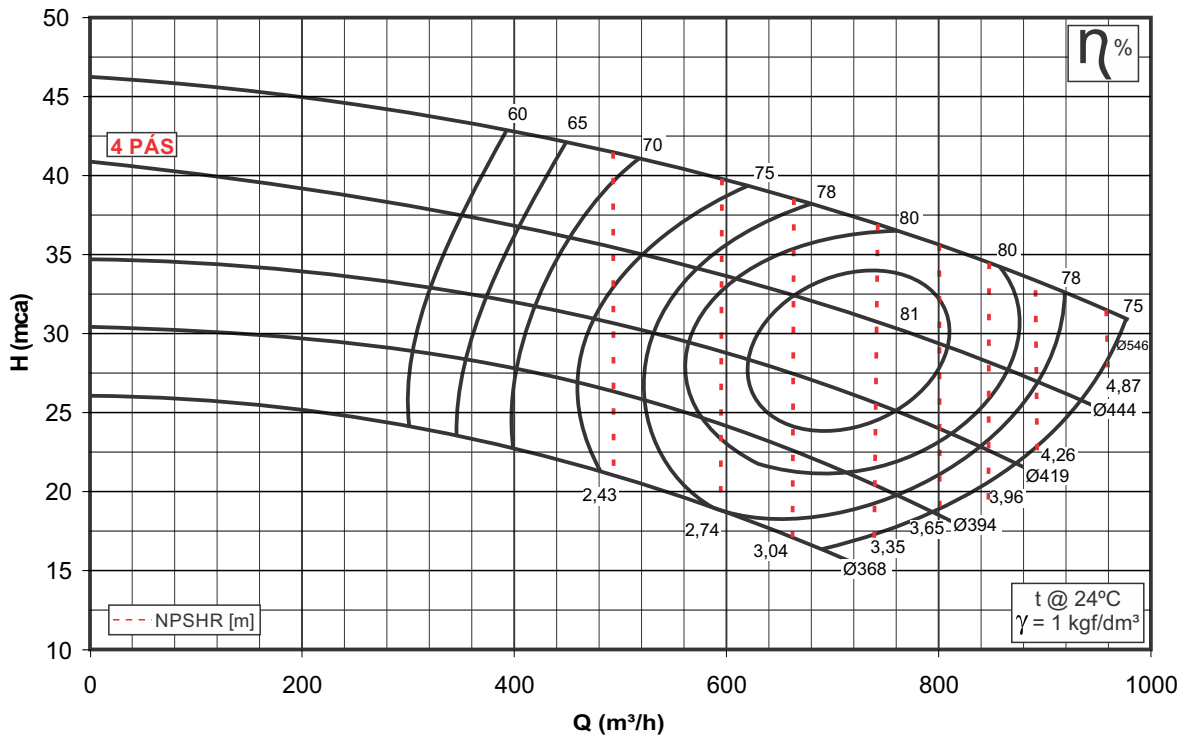



BMS 8X10X22

1180 RPM

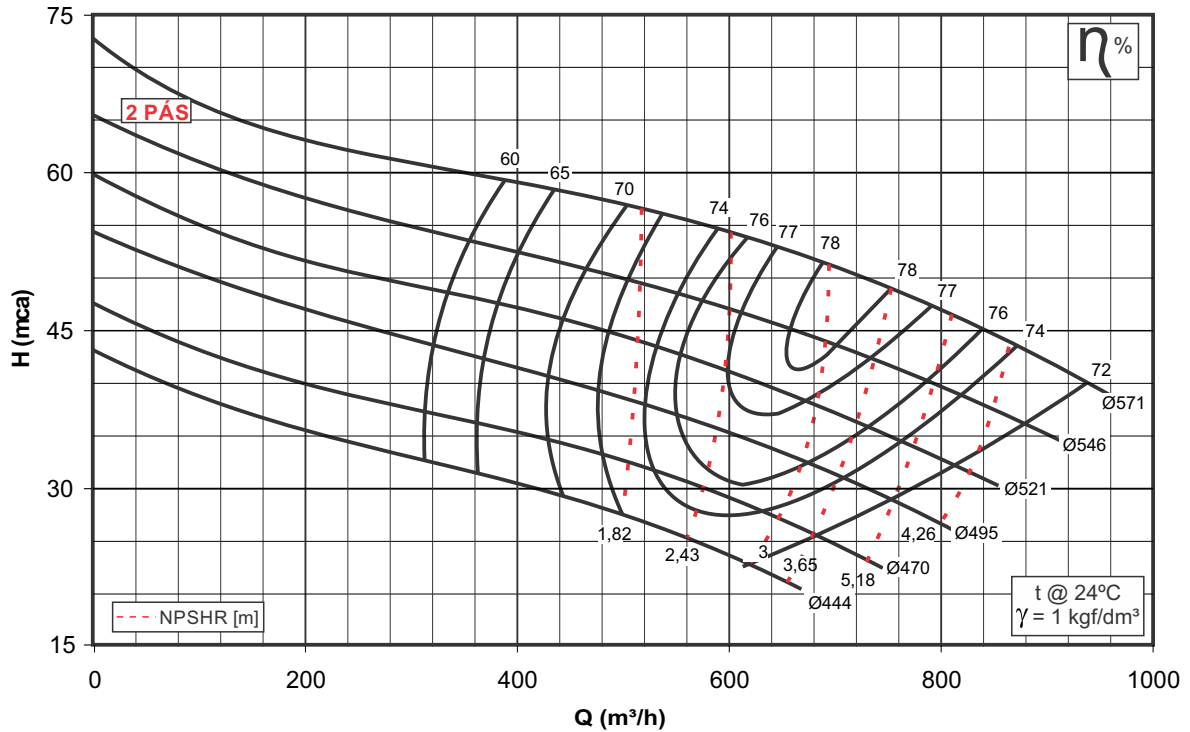

BMS 8X10X22

1180 RPM

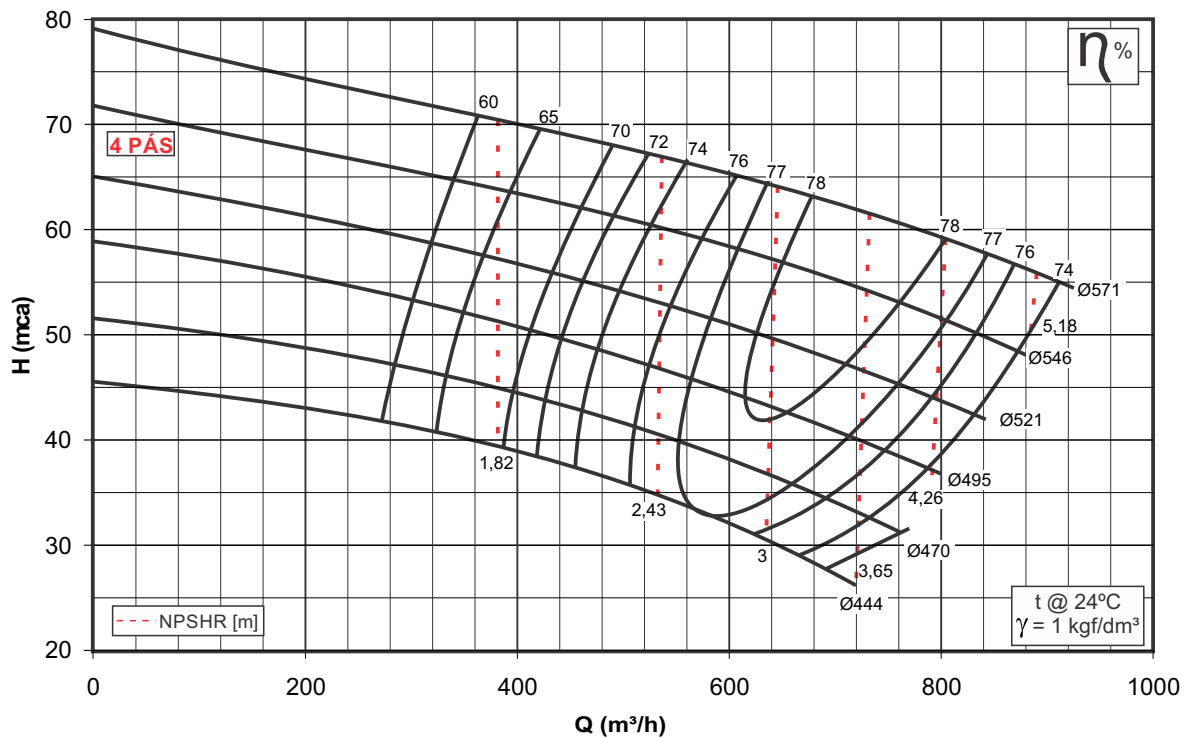



BMS 10X12X18

1180 RPM

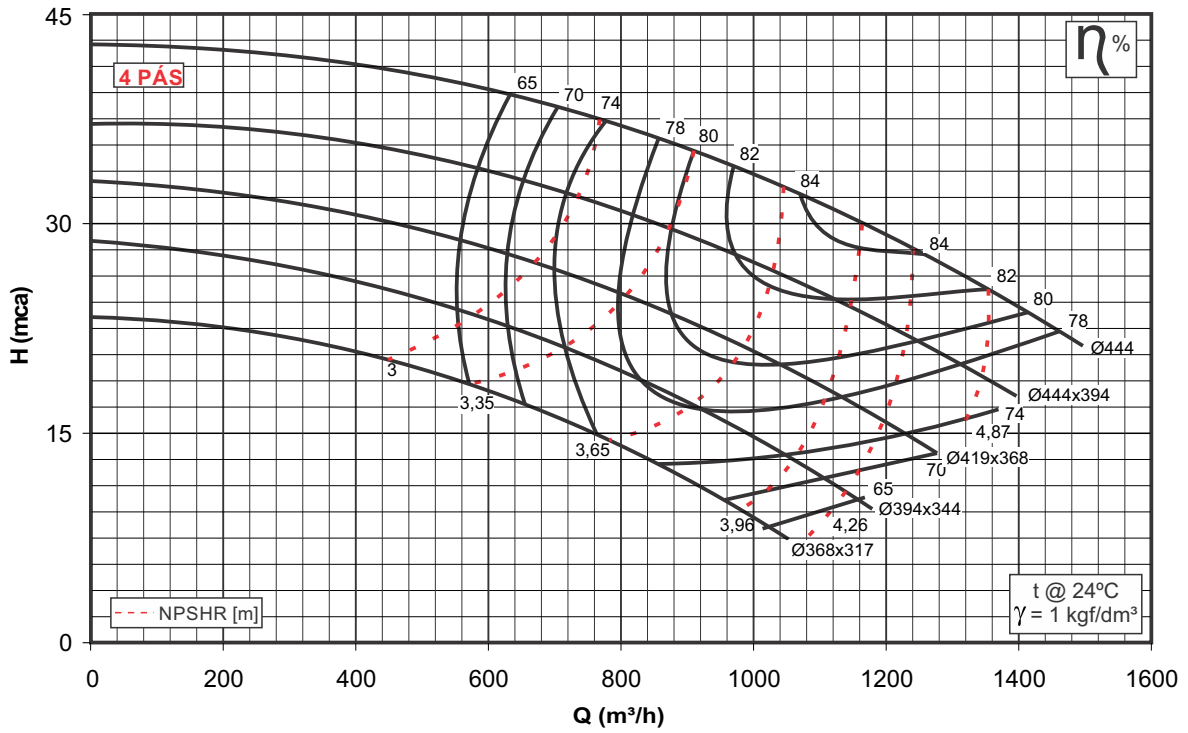

BMS 10X12X22

1180 RPM

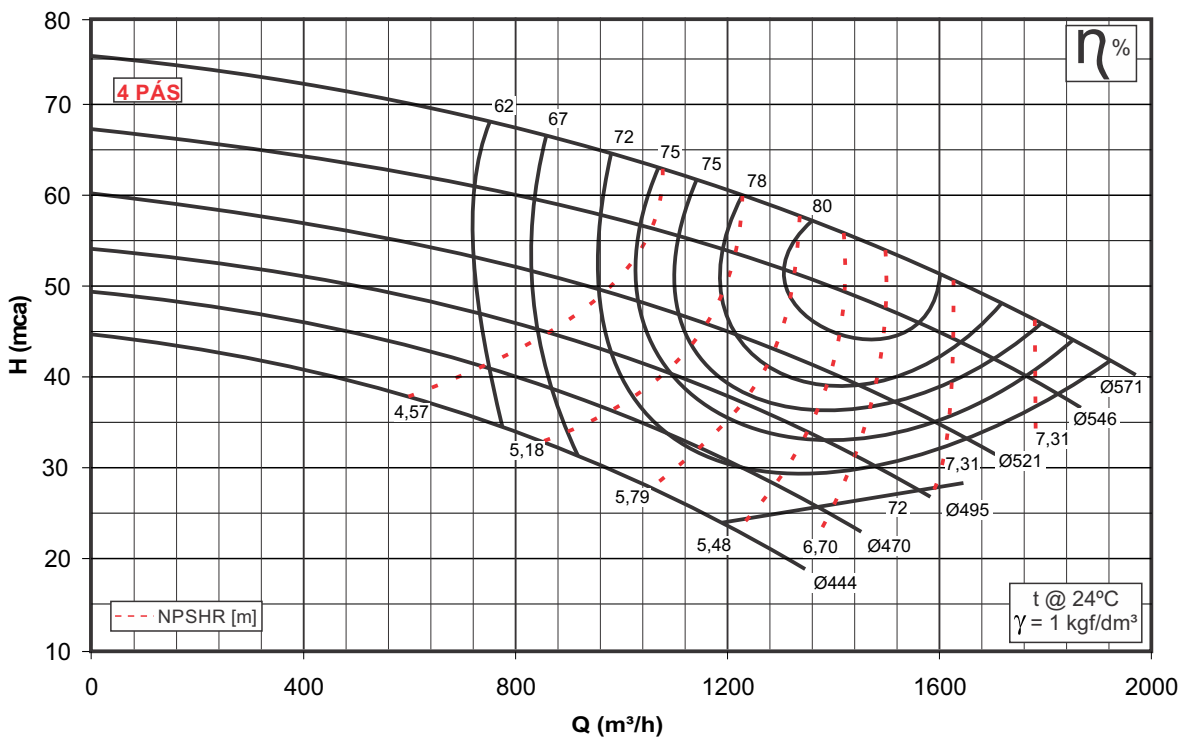



BMS 12X14X18

1180 RPM

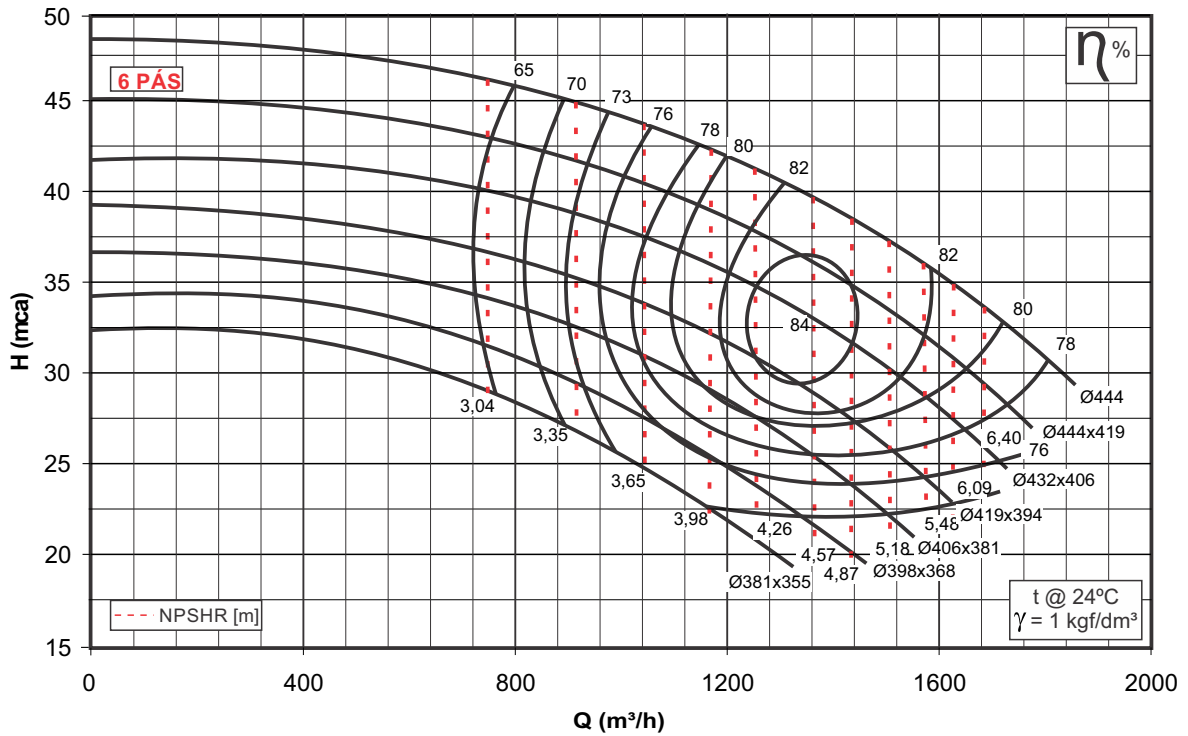

BMS 12X14X18

1180 RPM

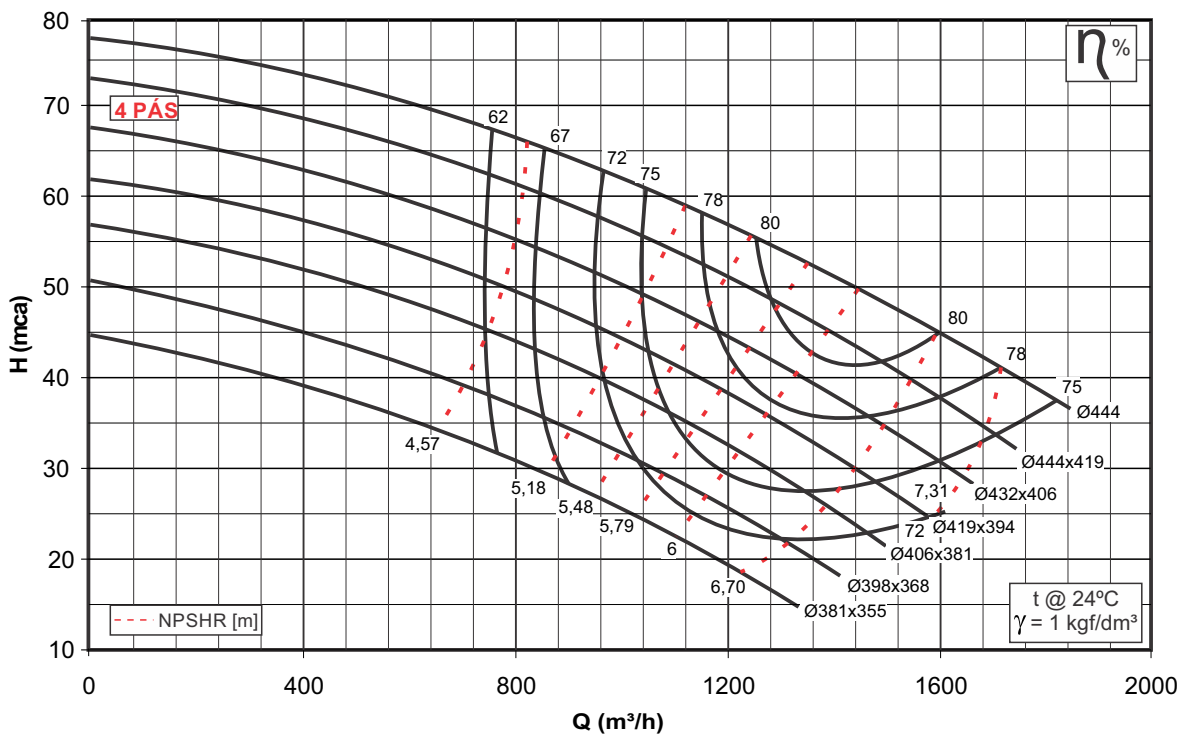



BMS 12X14X22

1180 RPM

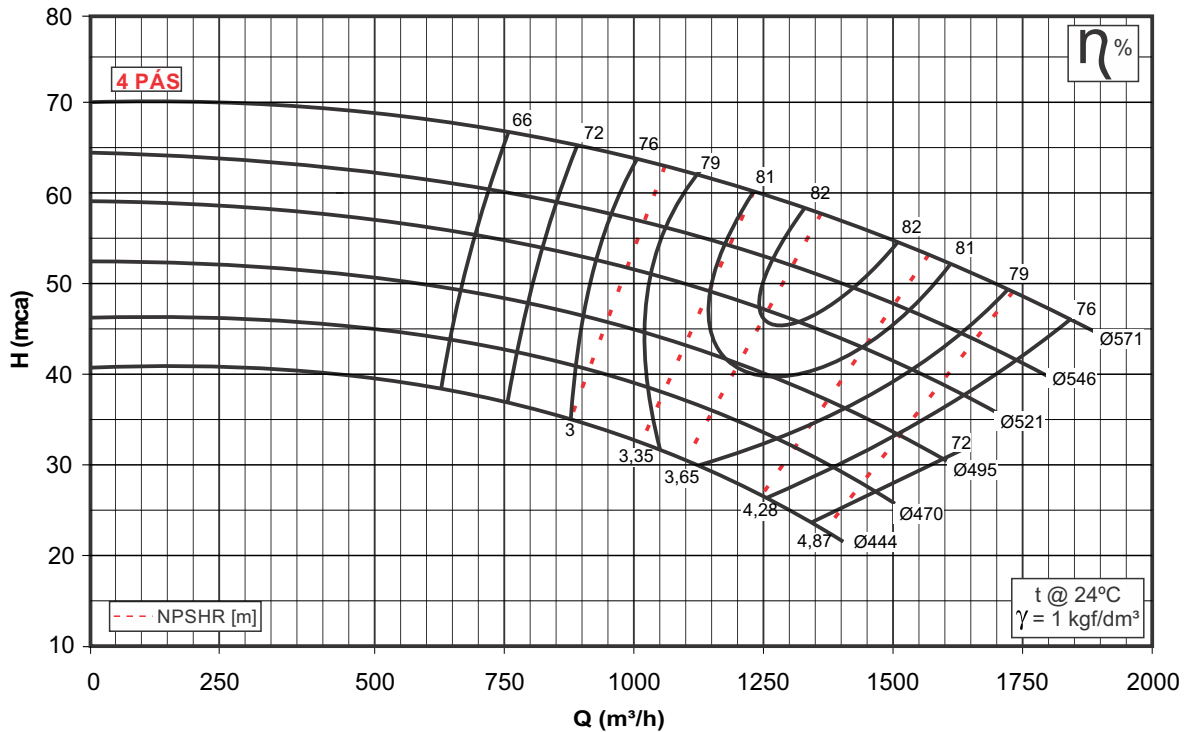

BMS 12X14X22

1180 RPM

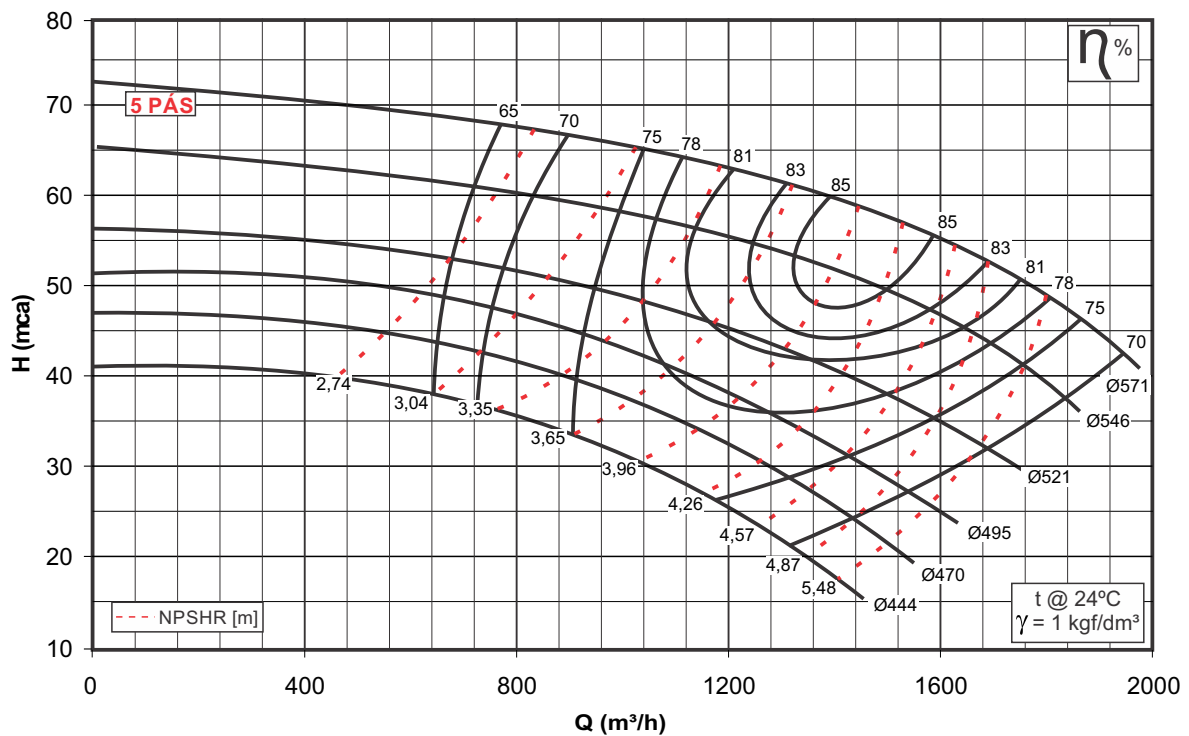



BMS 14X14X18

1180 RPM

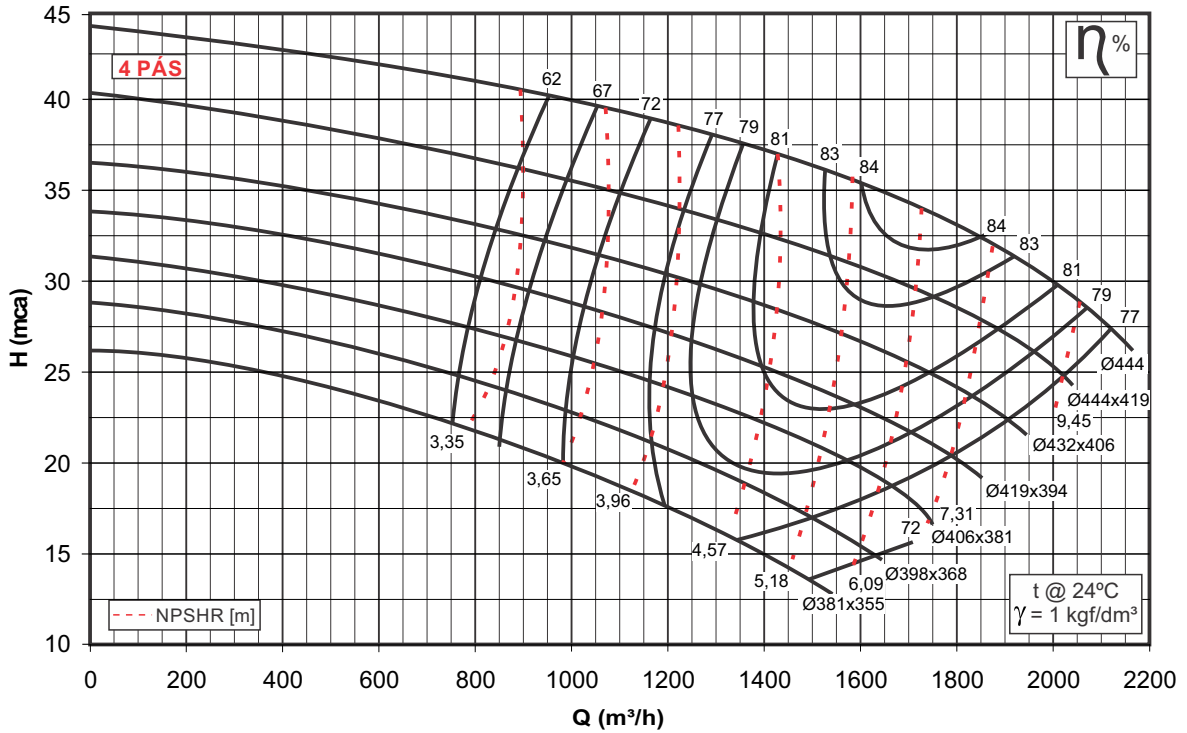

BMS 14X14X22

1180 RPM

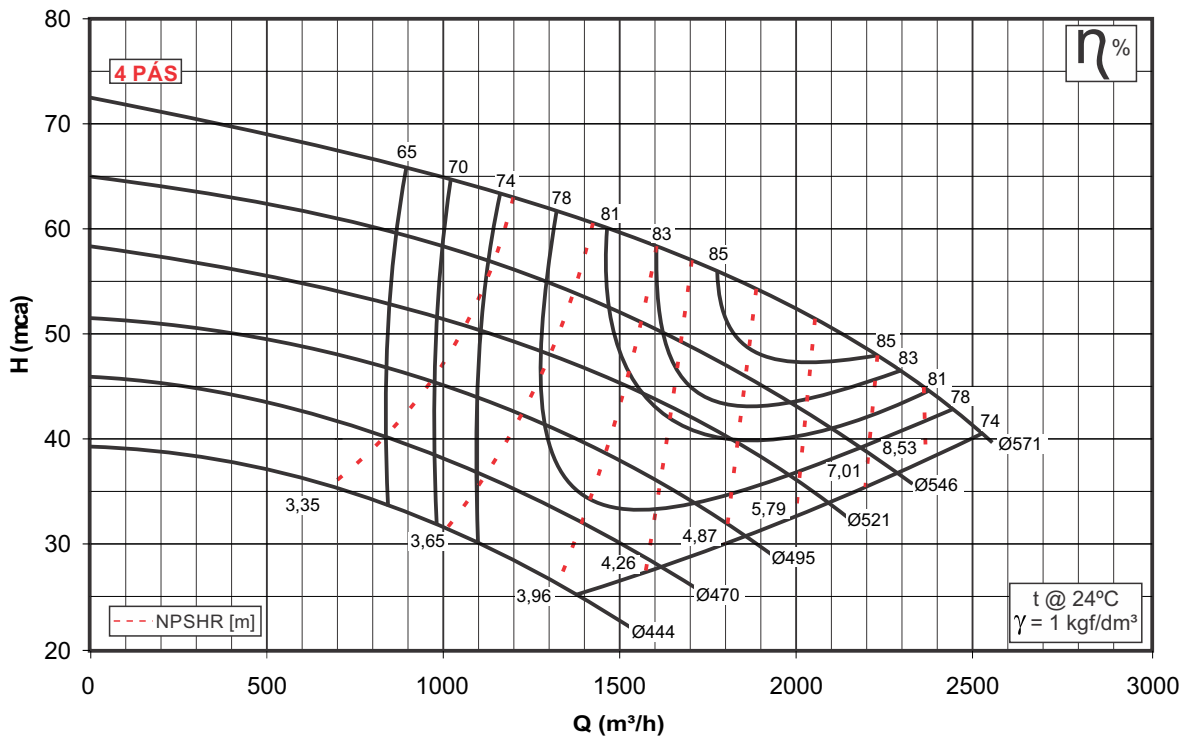



BMS 14X14X22

1180 RPM

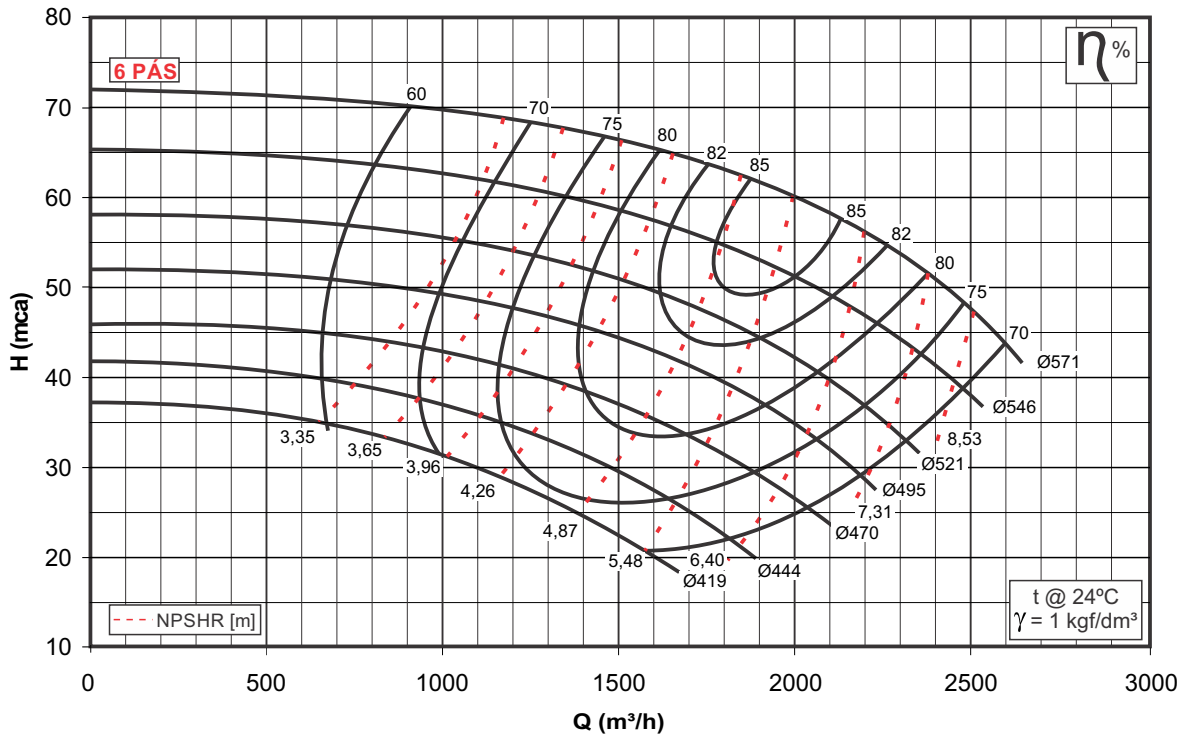



BMS 3X6X14

880 RPM

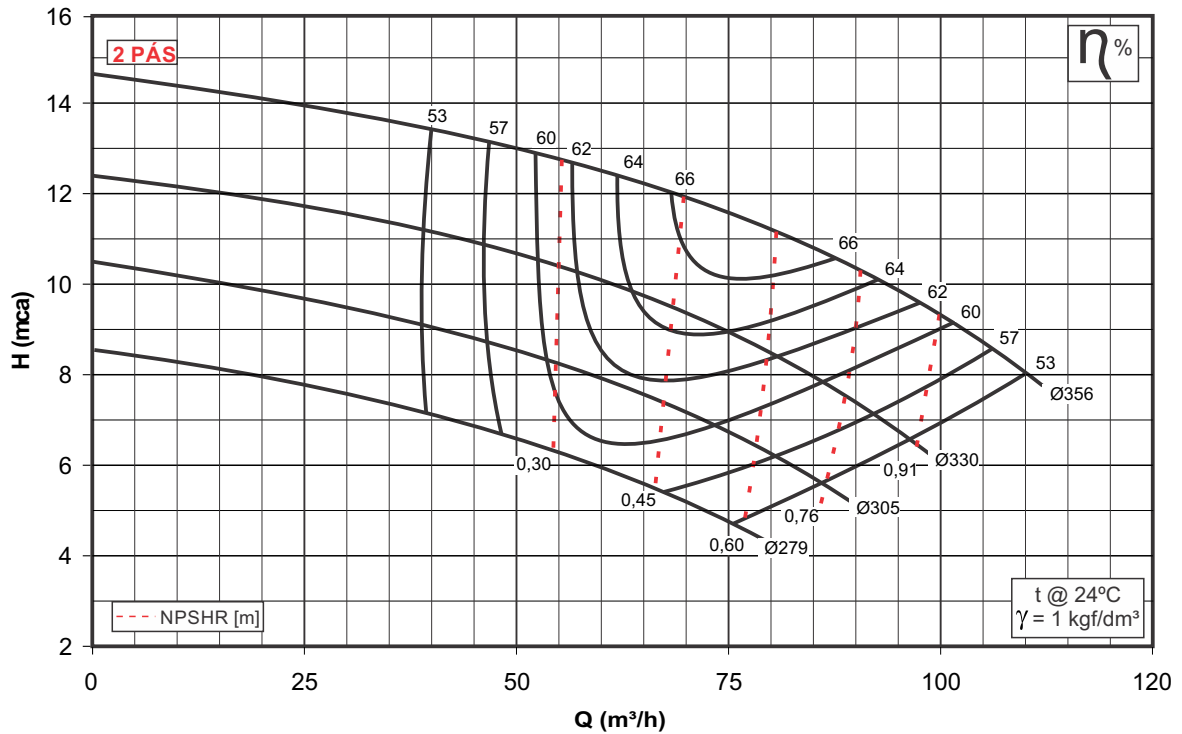

BMS 3X6X14

880 RPM

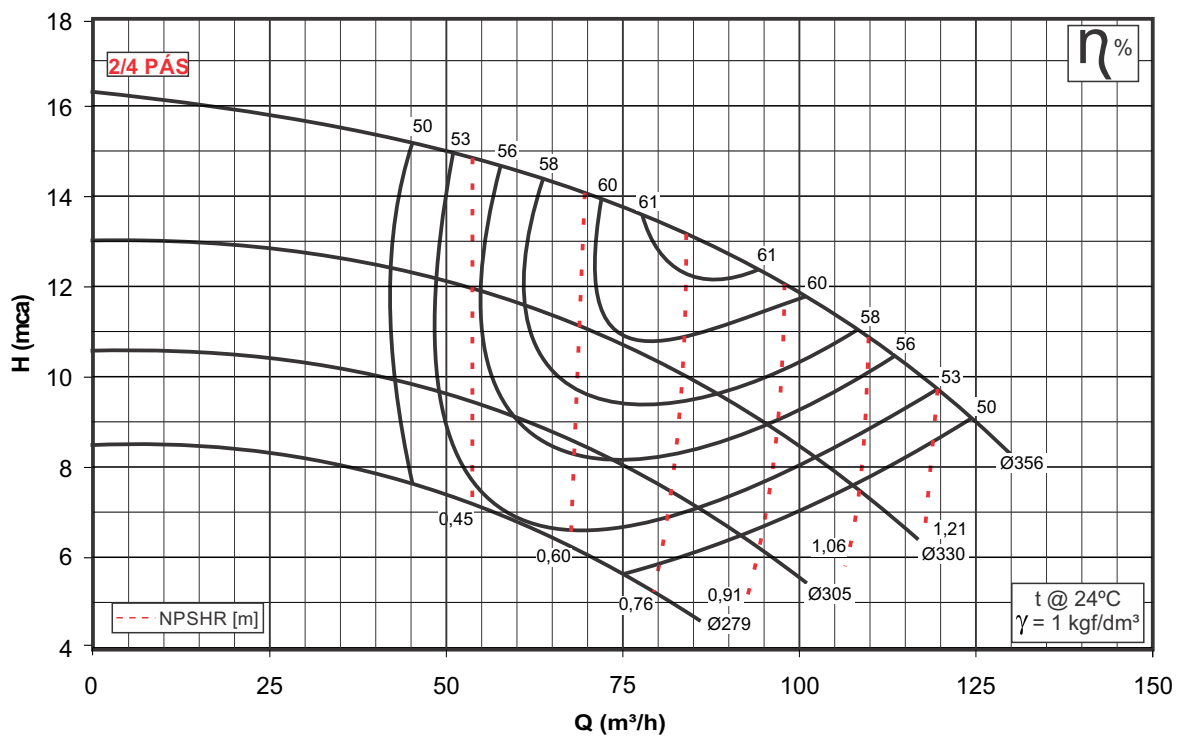



BMS 3X6X14

880 RPM

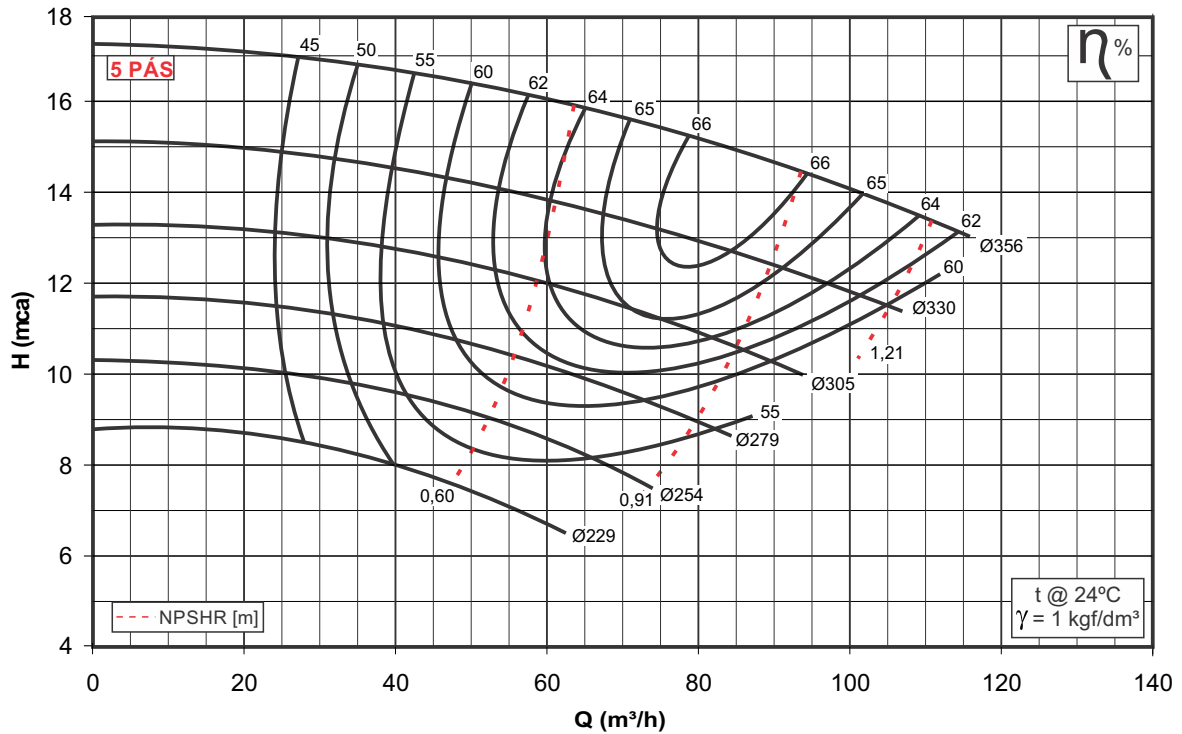

BMS 4X6X14

880 RPM

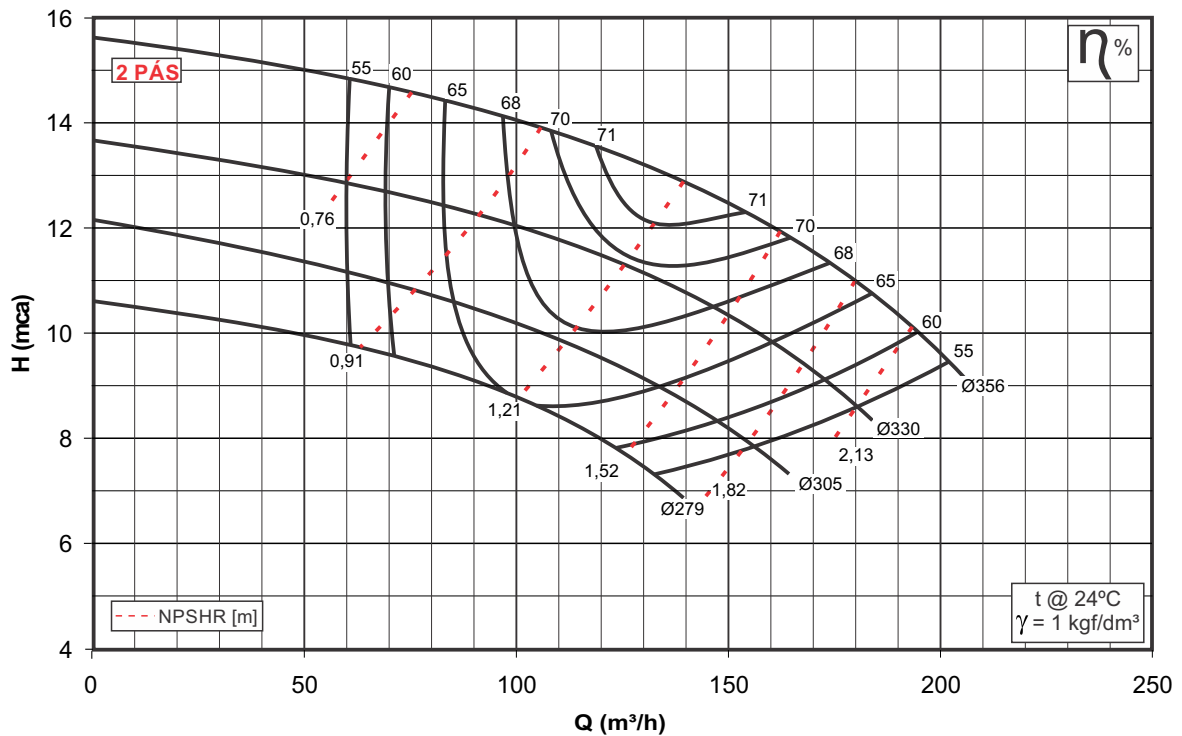



BMS 4X6X14

880 RPM

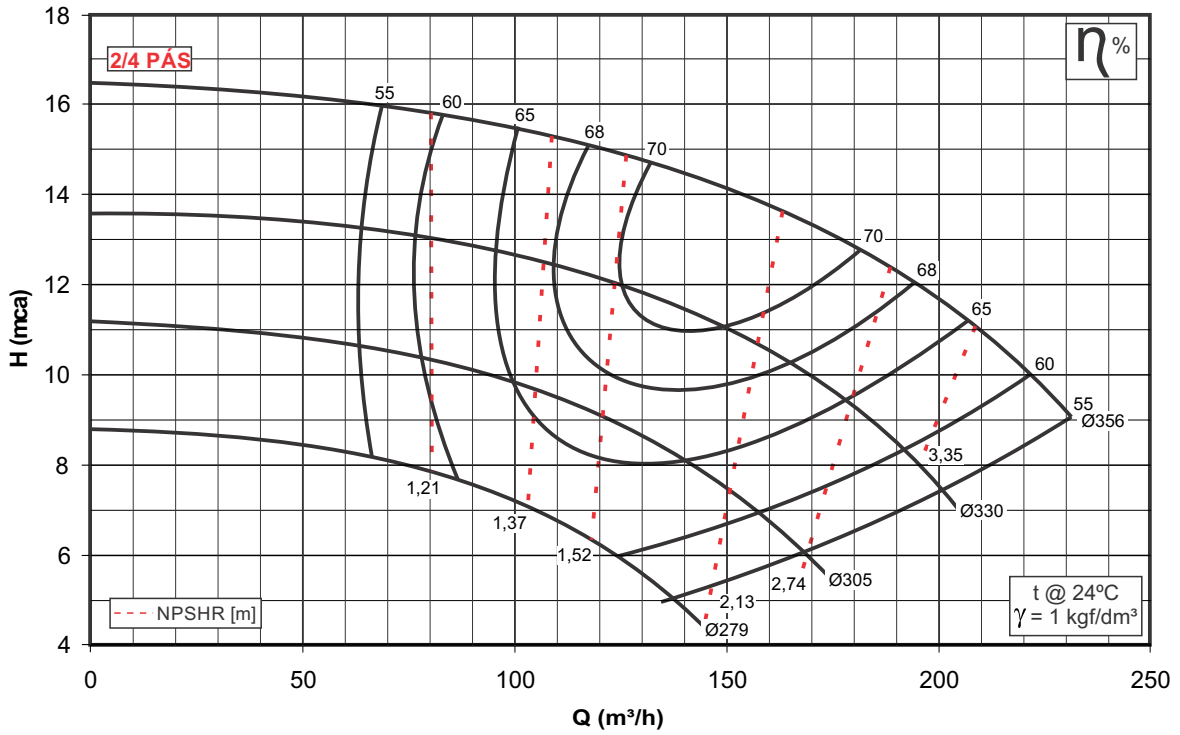

BMS 4X6X14

880 RPM

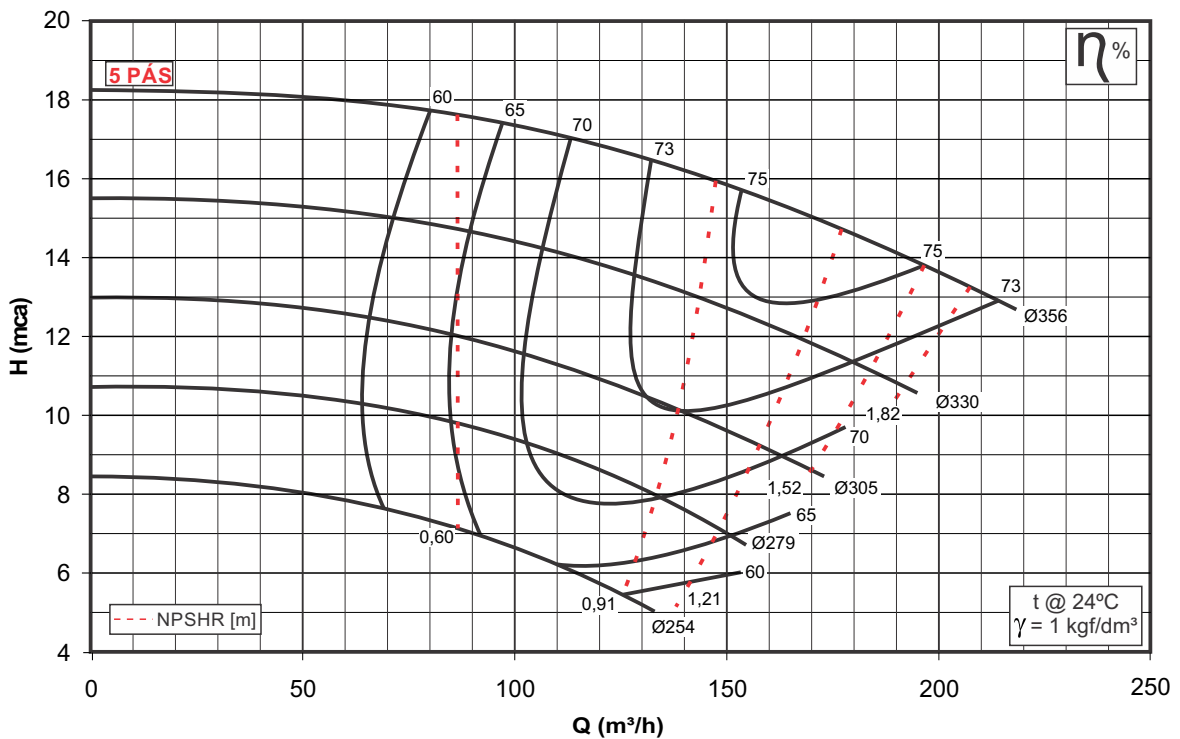



BMS 4X6X18

880 RPM

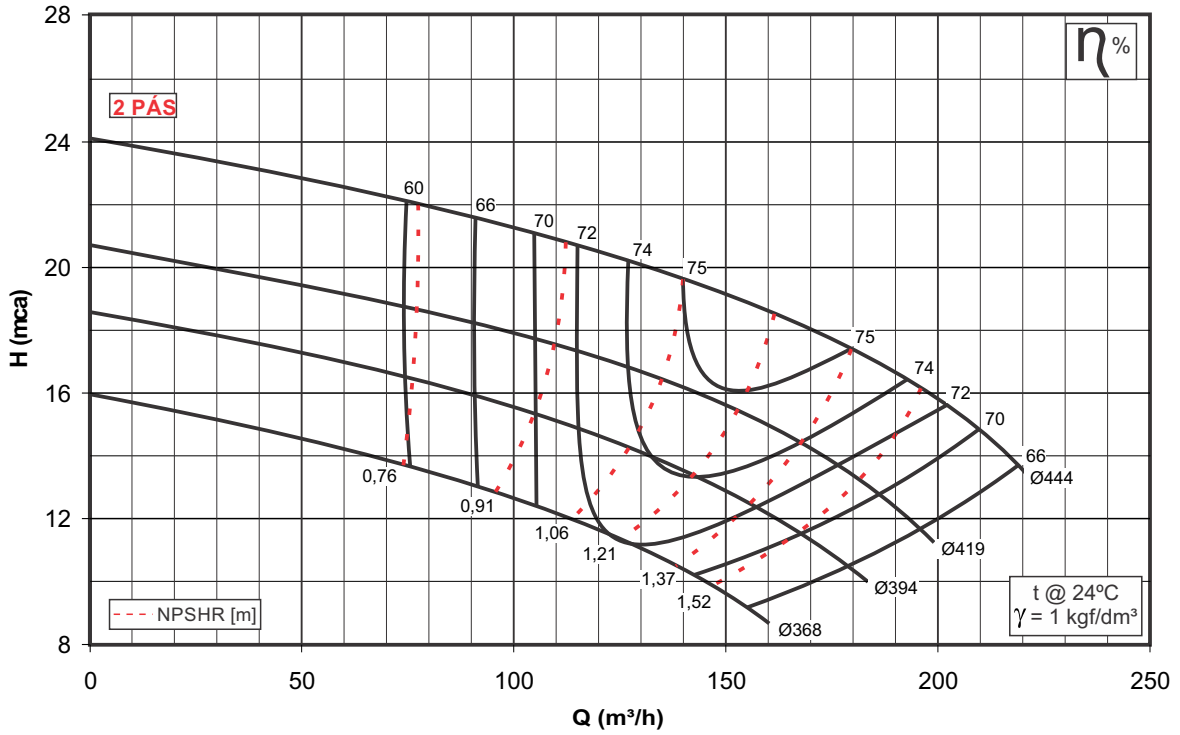

BMS 4X6X18

880 RPM

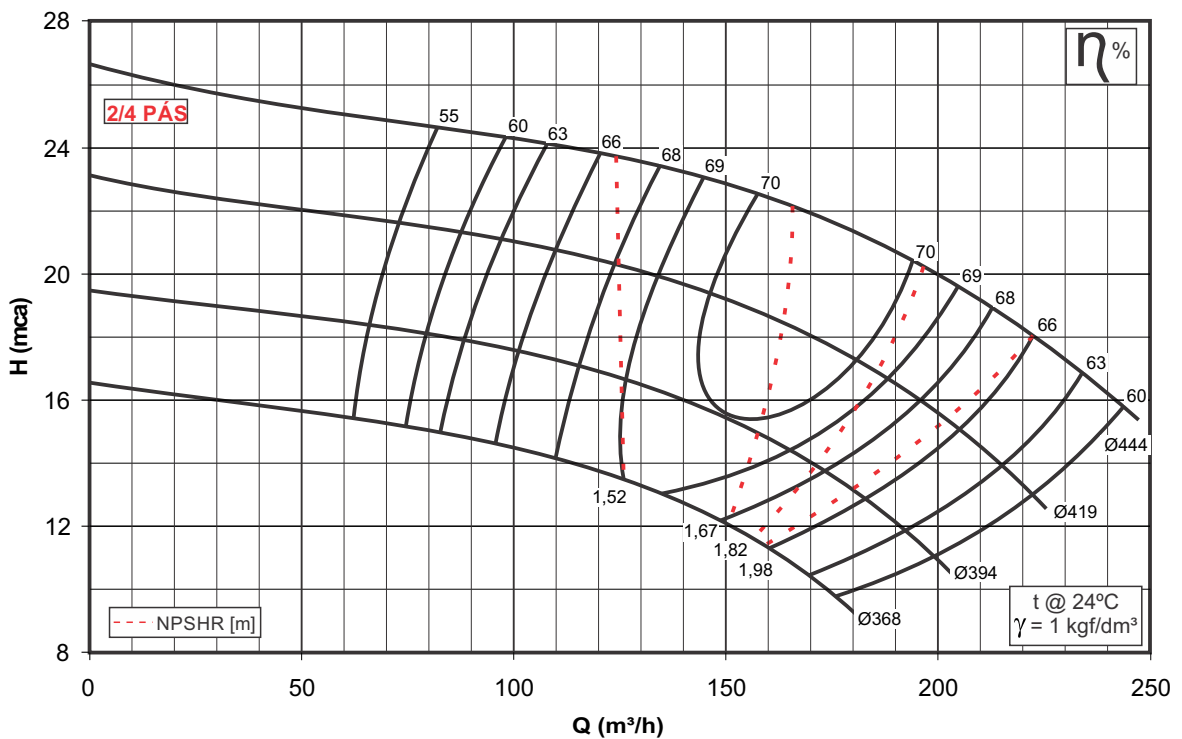



BMS 6X8X14

880 RPM

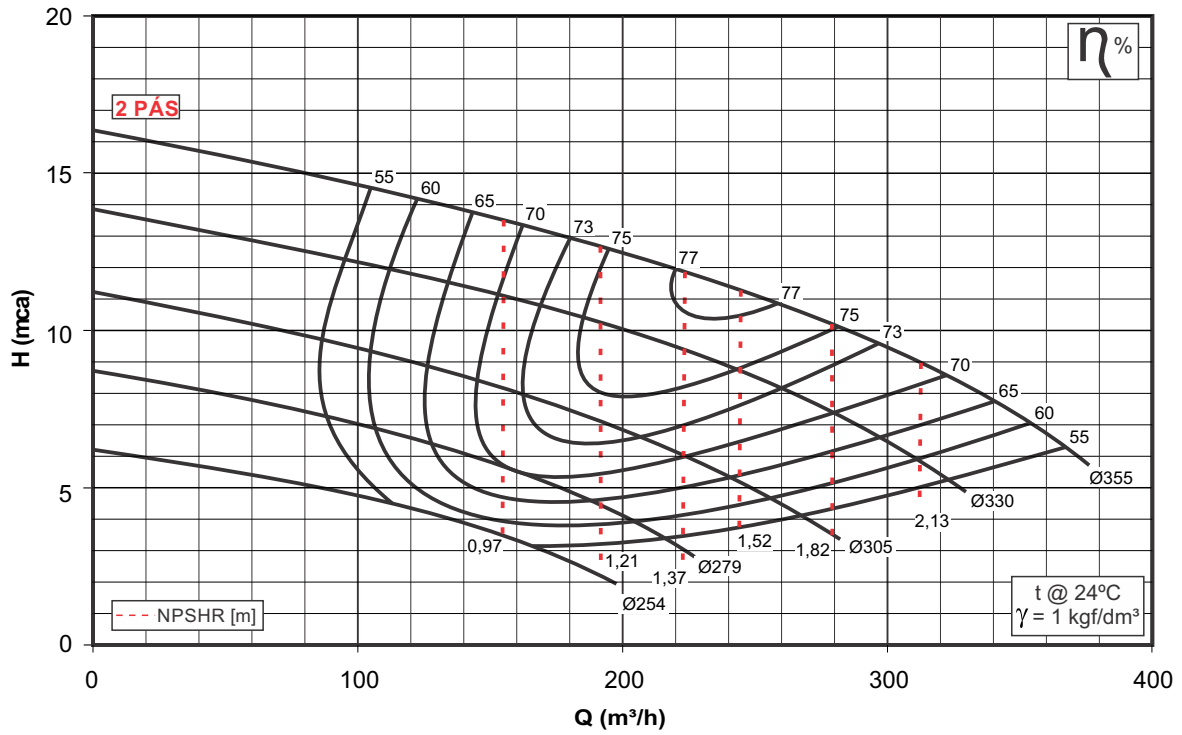

BMS 6X8X14

880 RPM

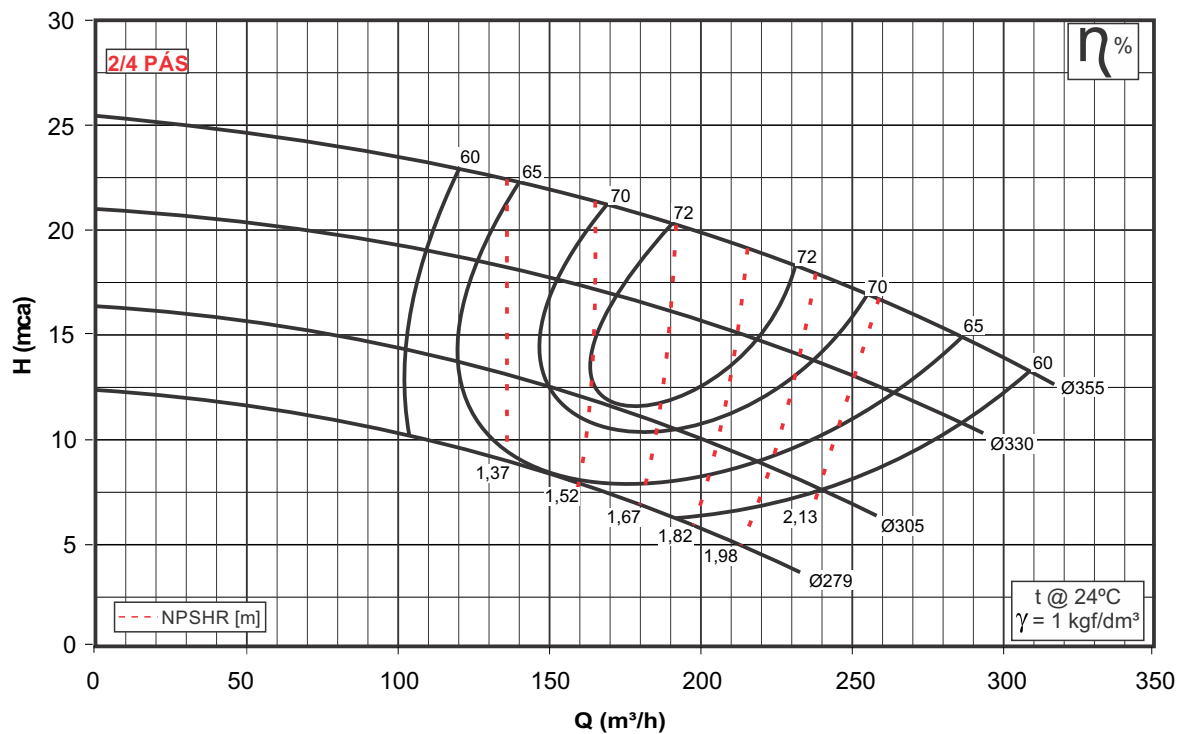



BMS 6X8X18

880 RPM

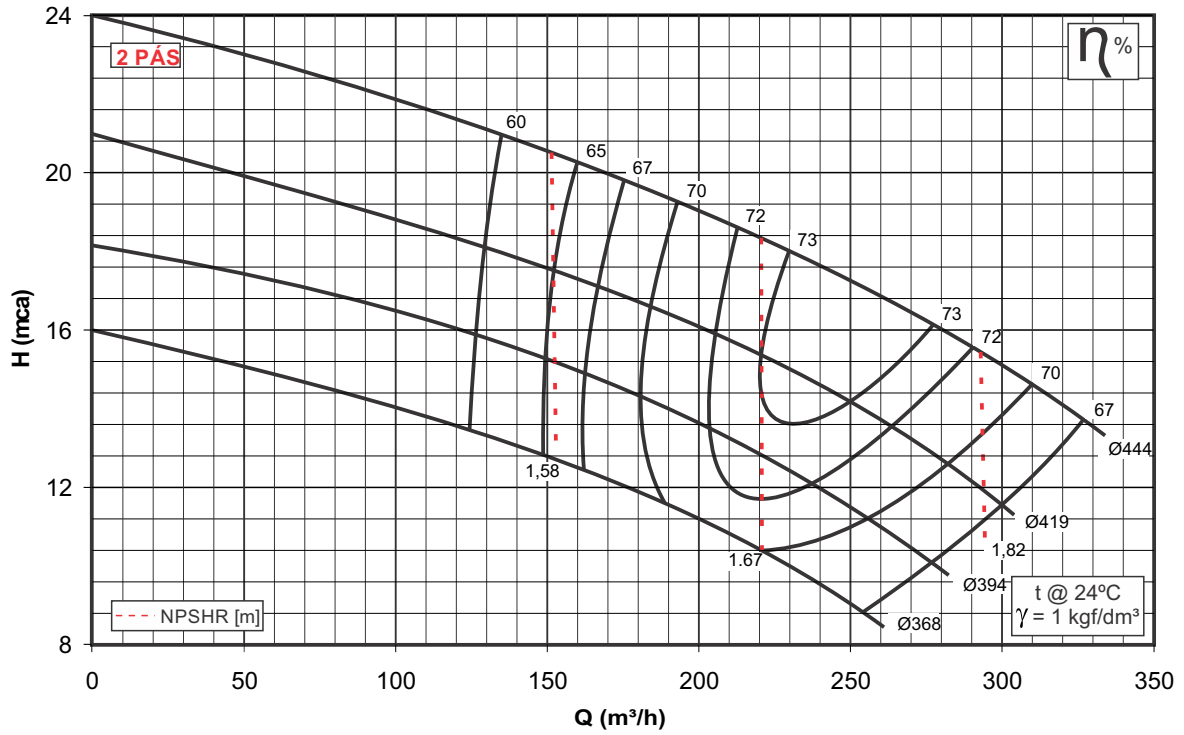

BMS 6X8X18

880 RPM

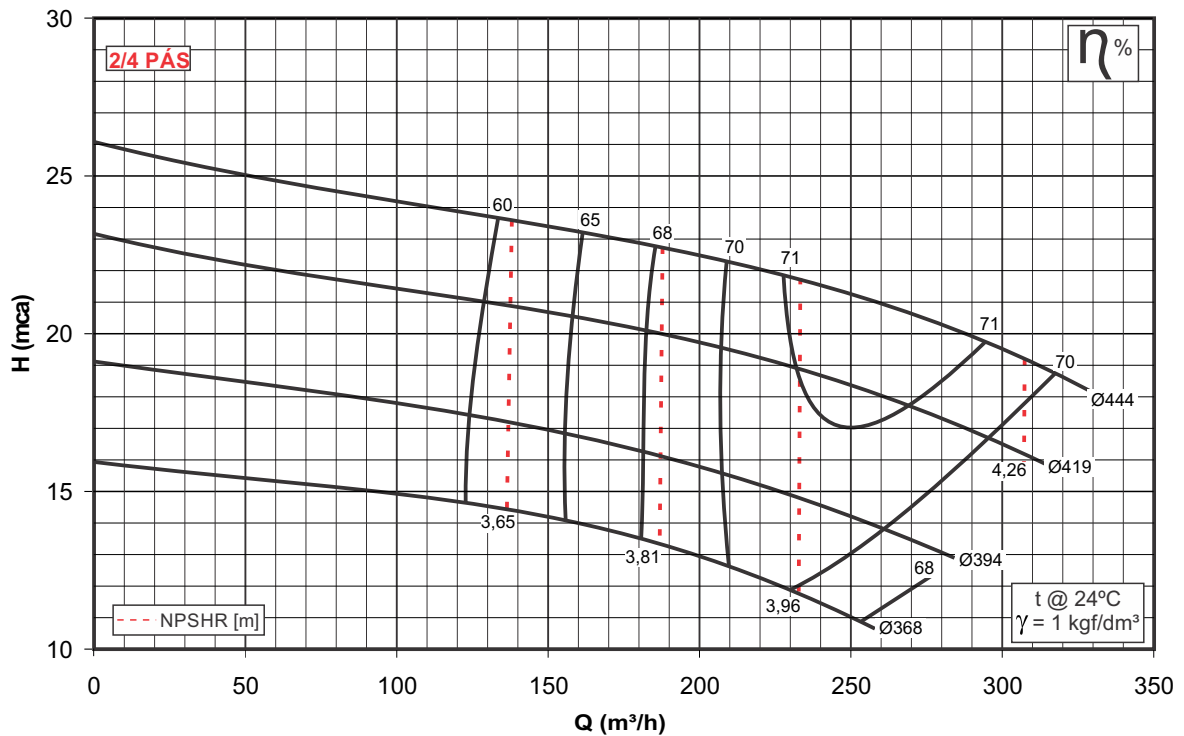



BMS 6X8X18

880 RPM

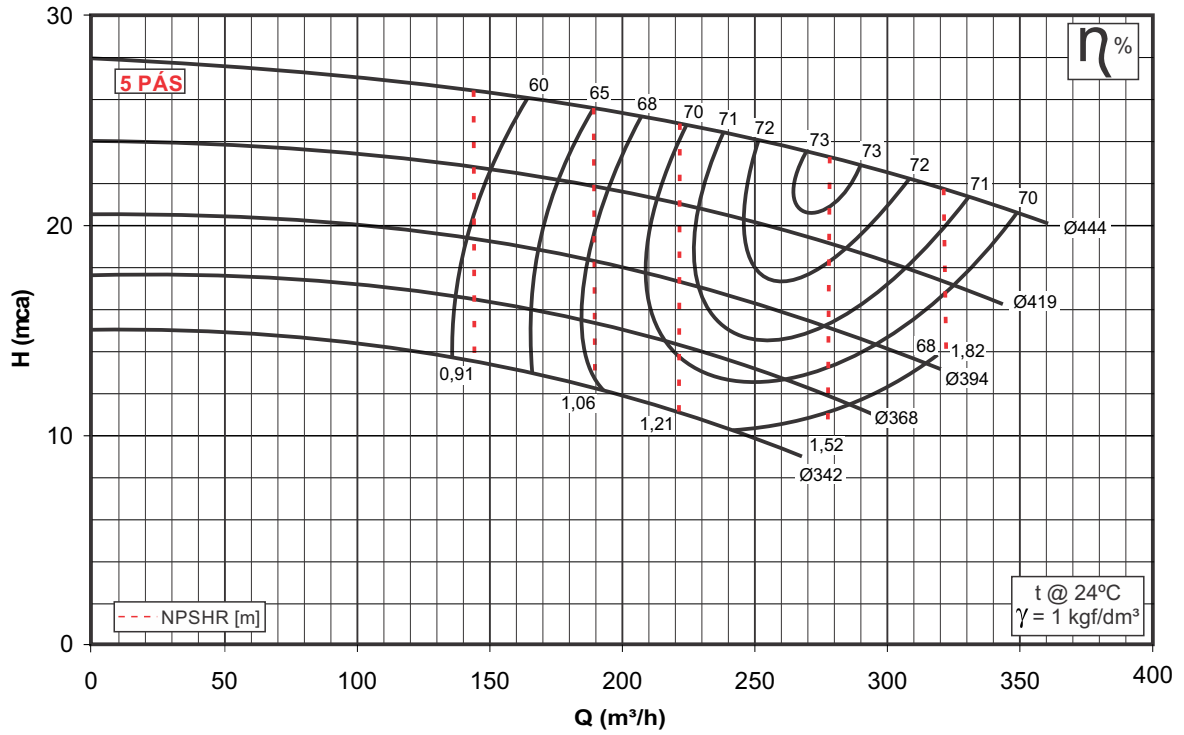

BMS 6X8X22

880 RPM

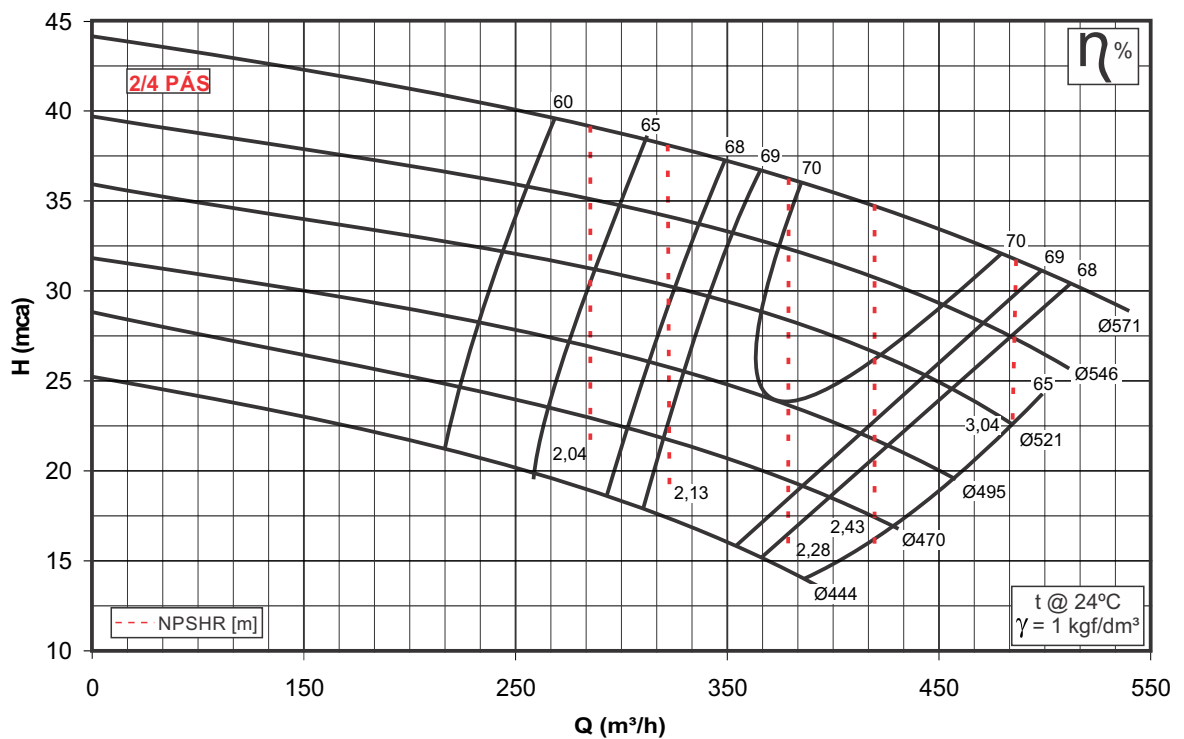



BMS 6X8X22

880 RPM

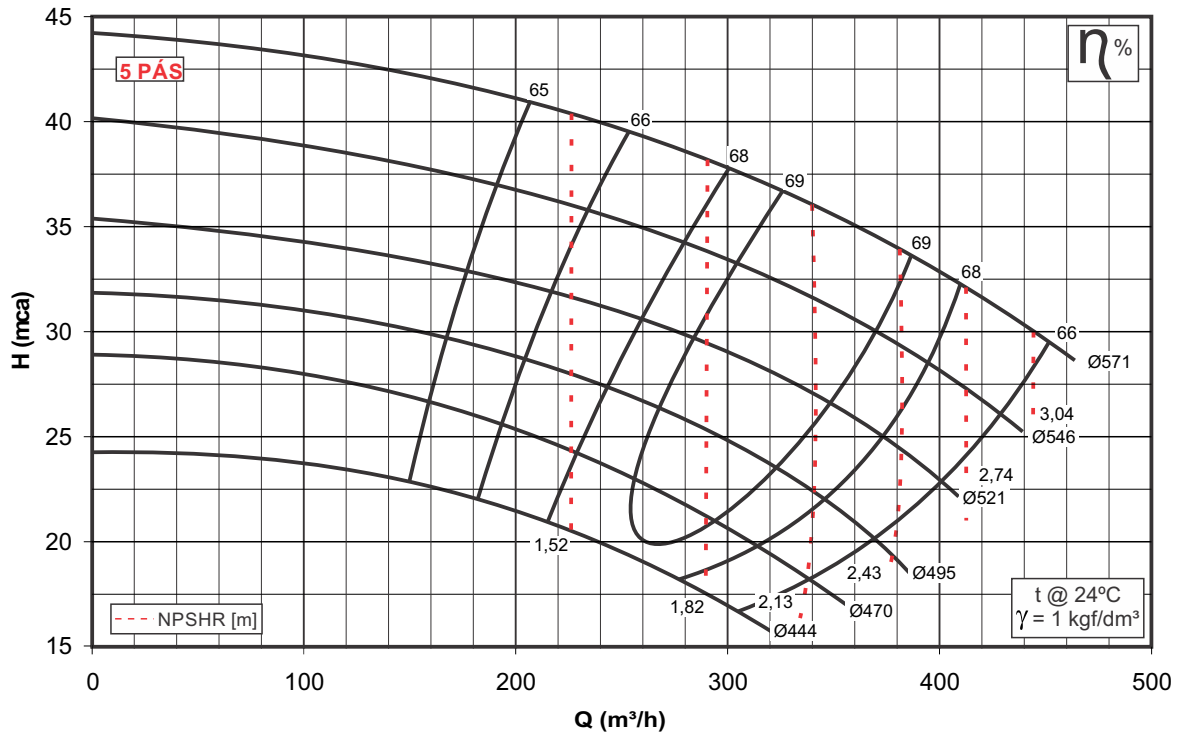

BMS 8X10X14

880 RPM

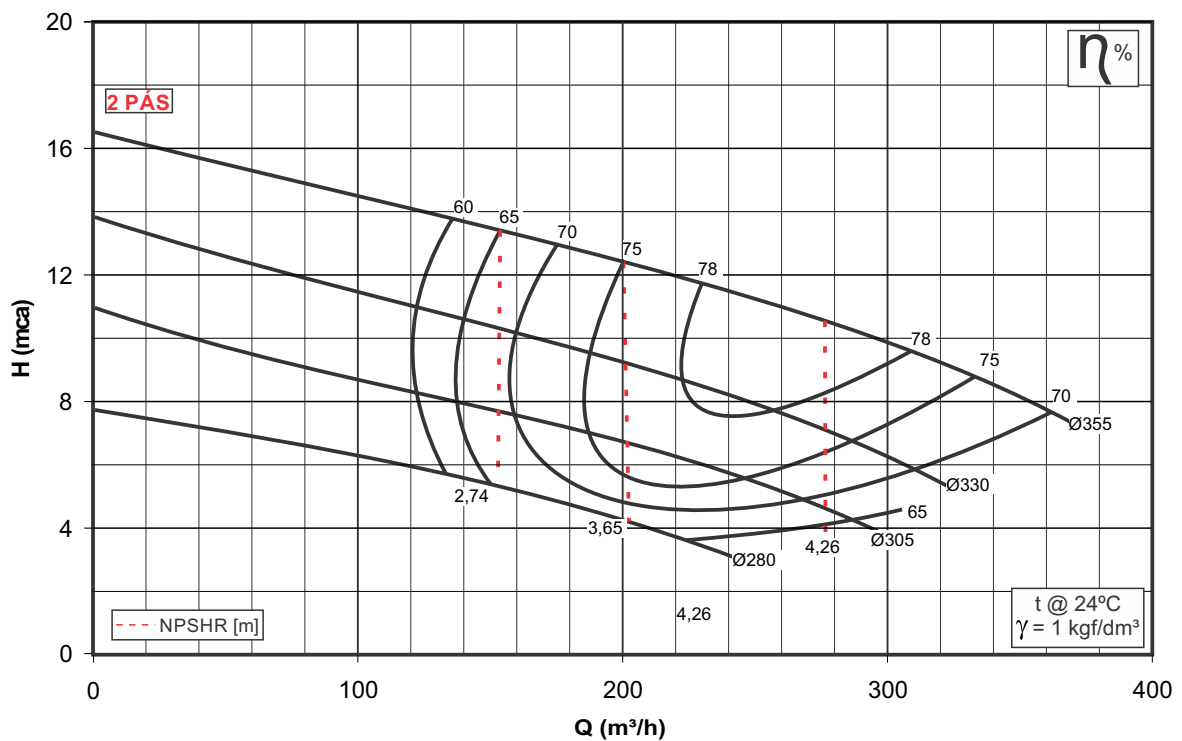



BMS 8X10X18

880 RPM

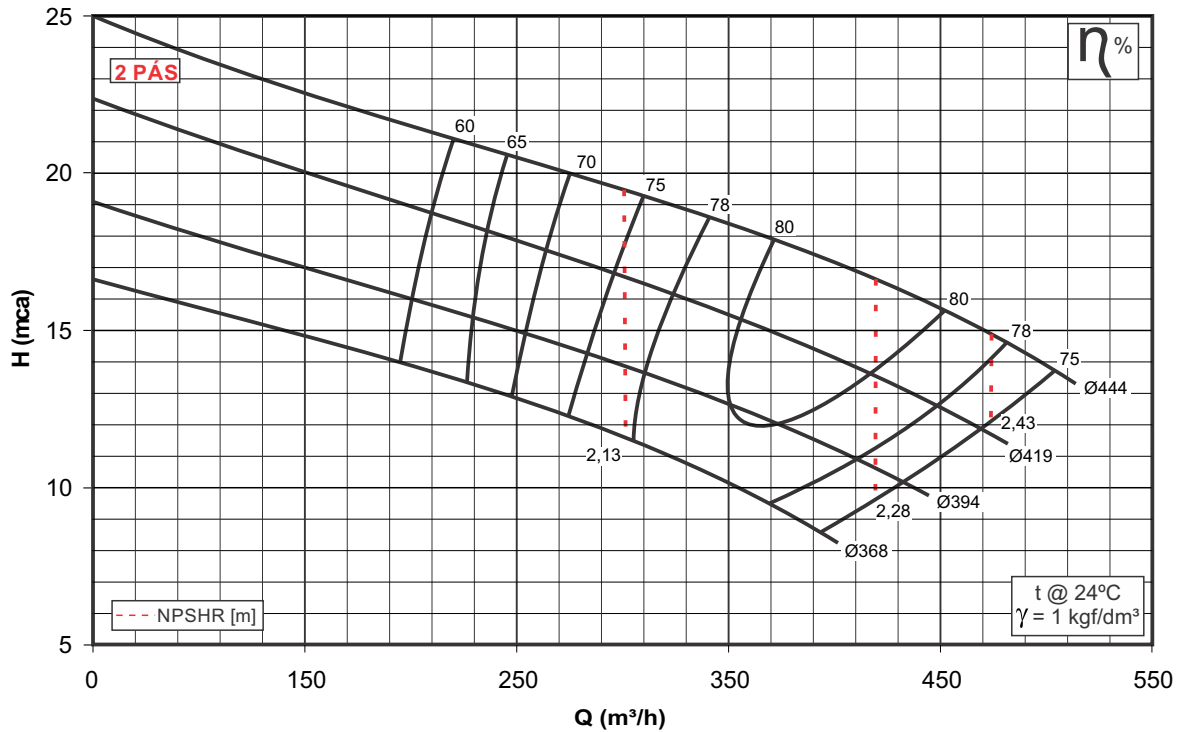

BMS 8X10X18

880 RPM

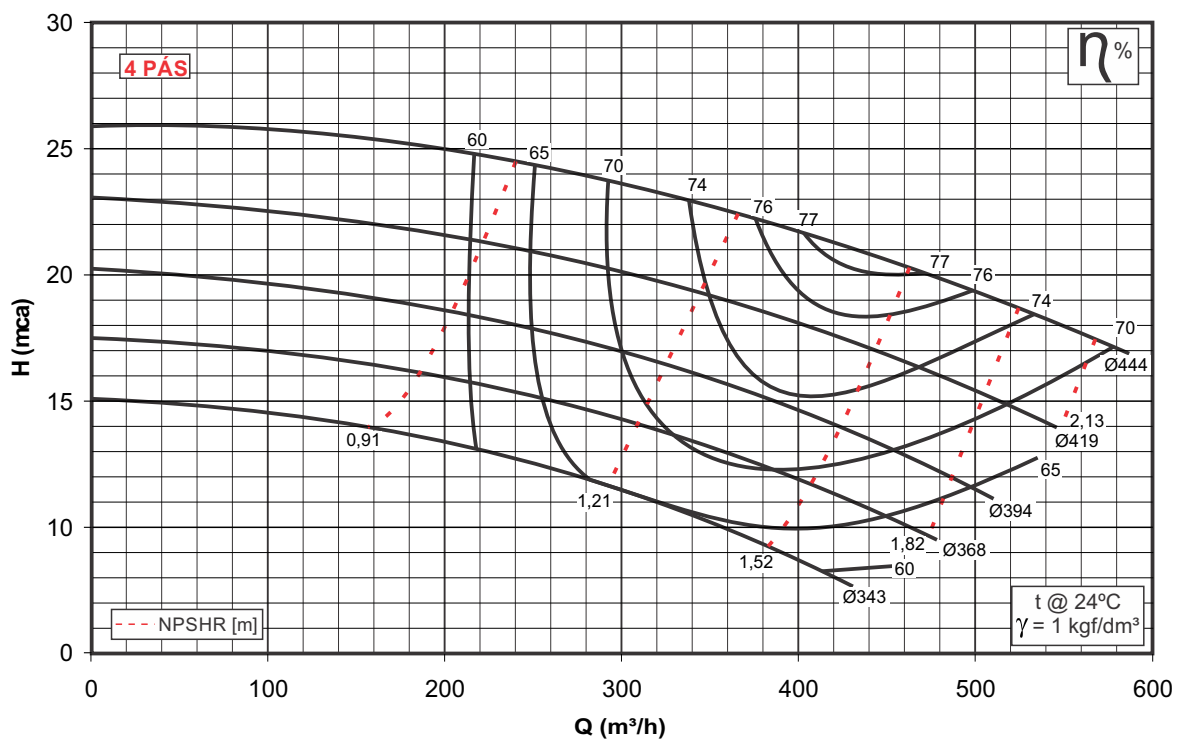



BMS 8X10X22

880 RPM

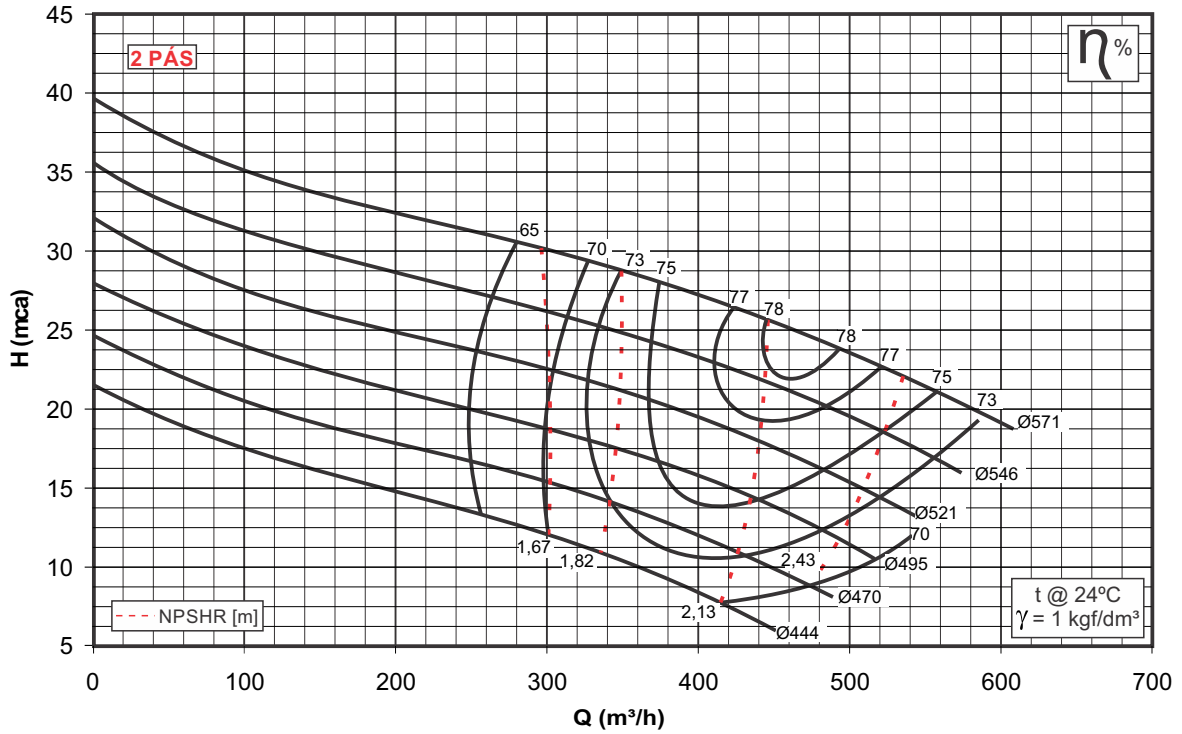

BMS 8X10X22

880 RPM

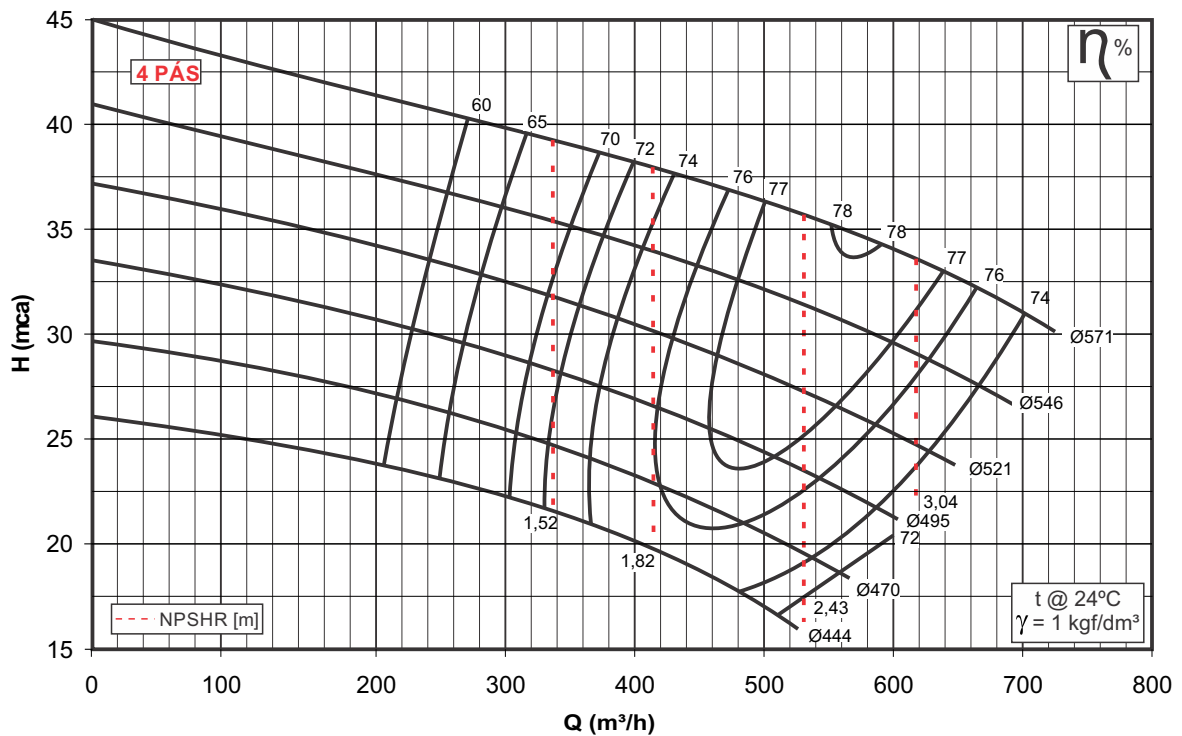



BMS 10X12X18

880 RPM

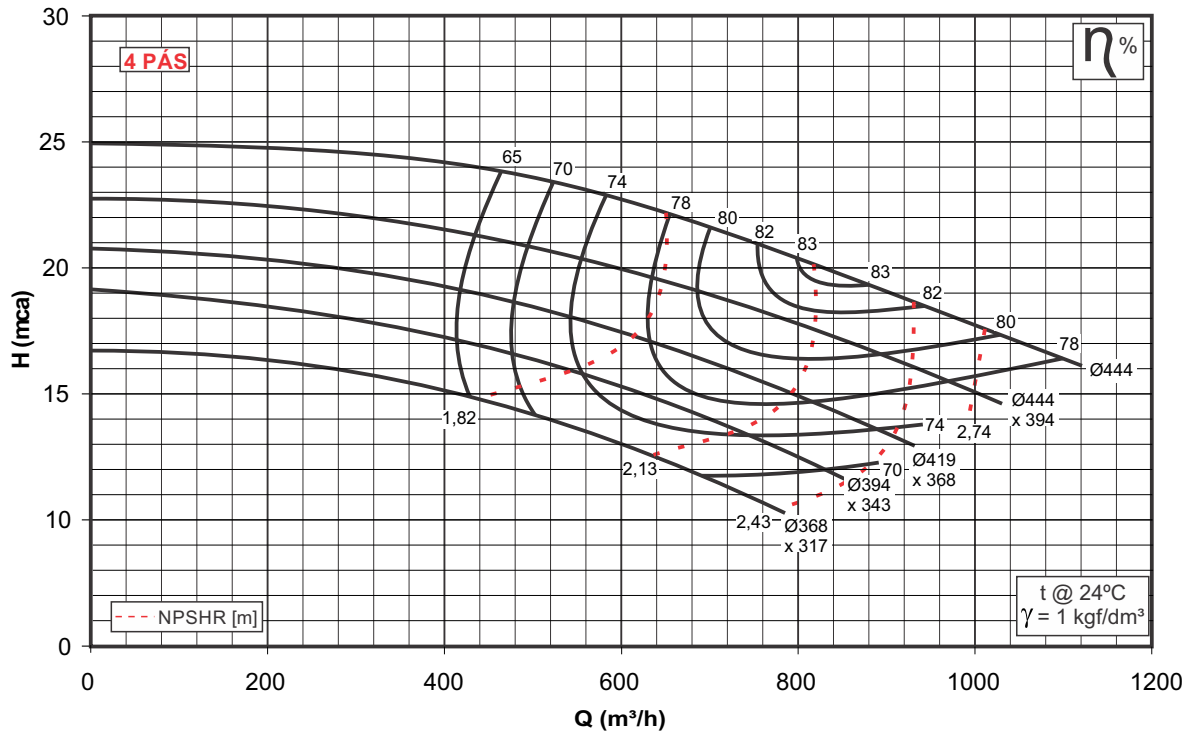

BMS 10X12X22

880 RPM

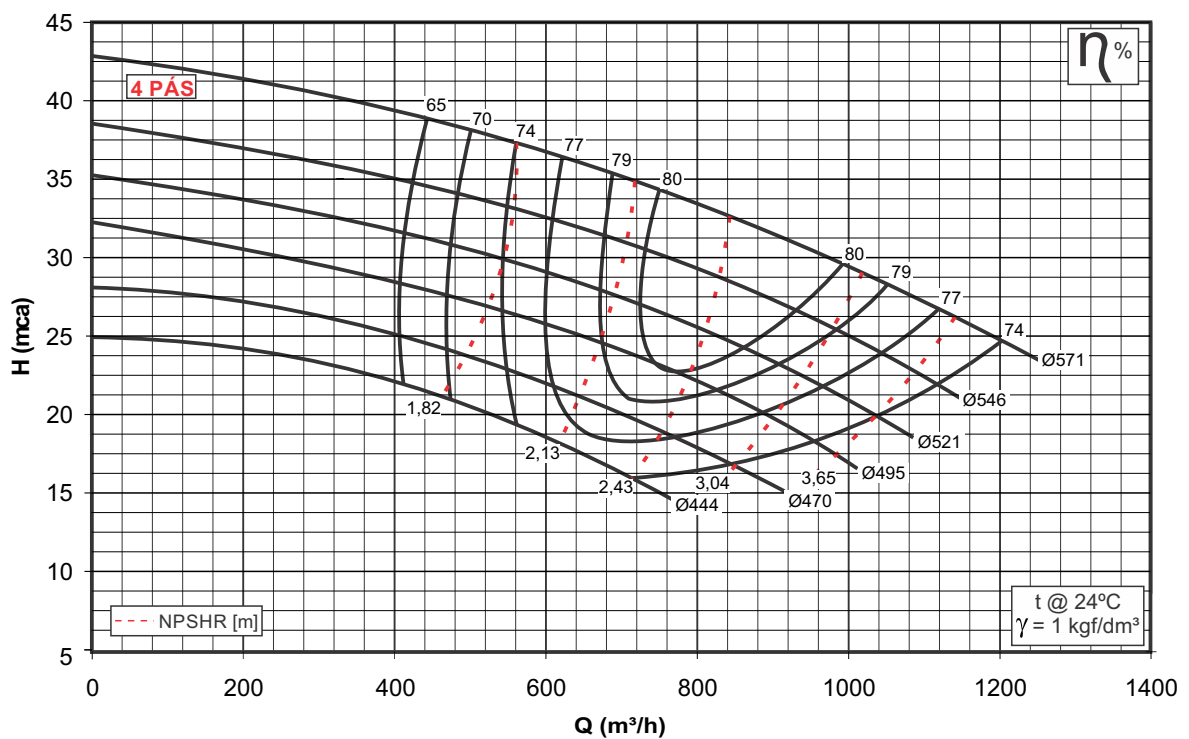



BMS 12X14X18

880 RPM

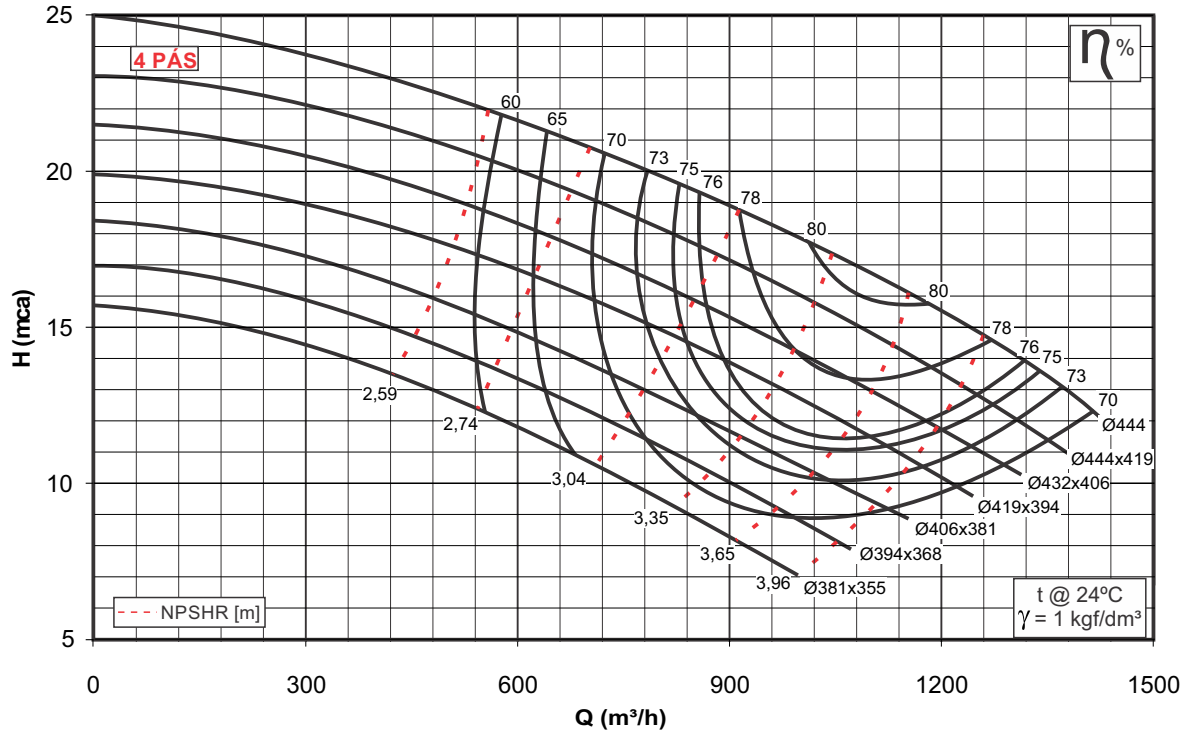

BMS 12X14X18

880 RPM

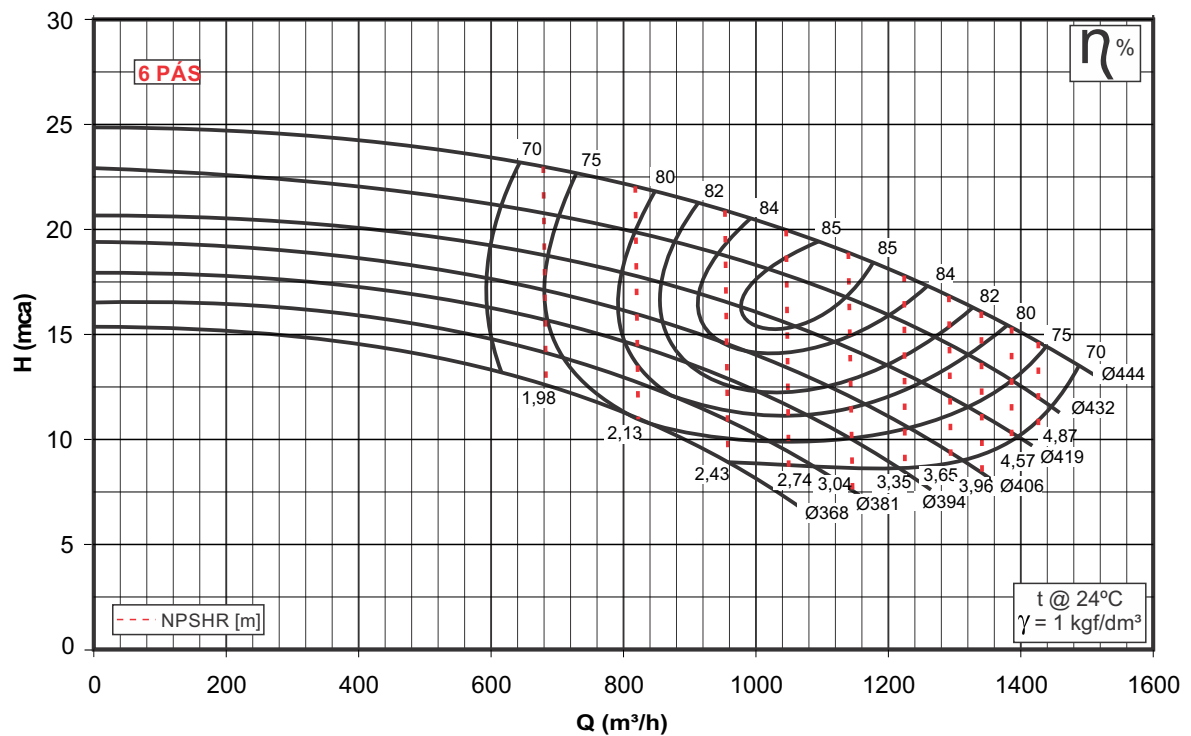



BMS 12X14X22

880 RPM

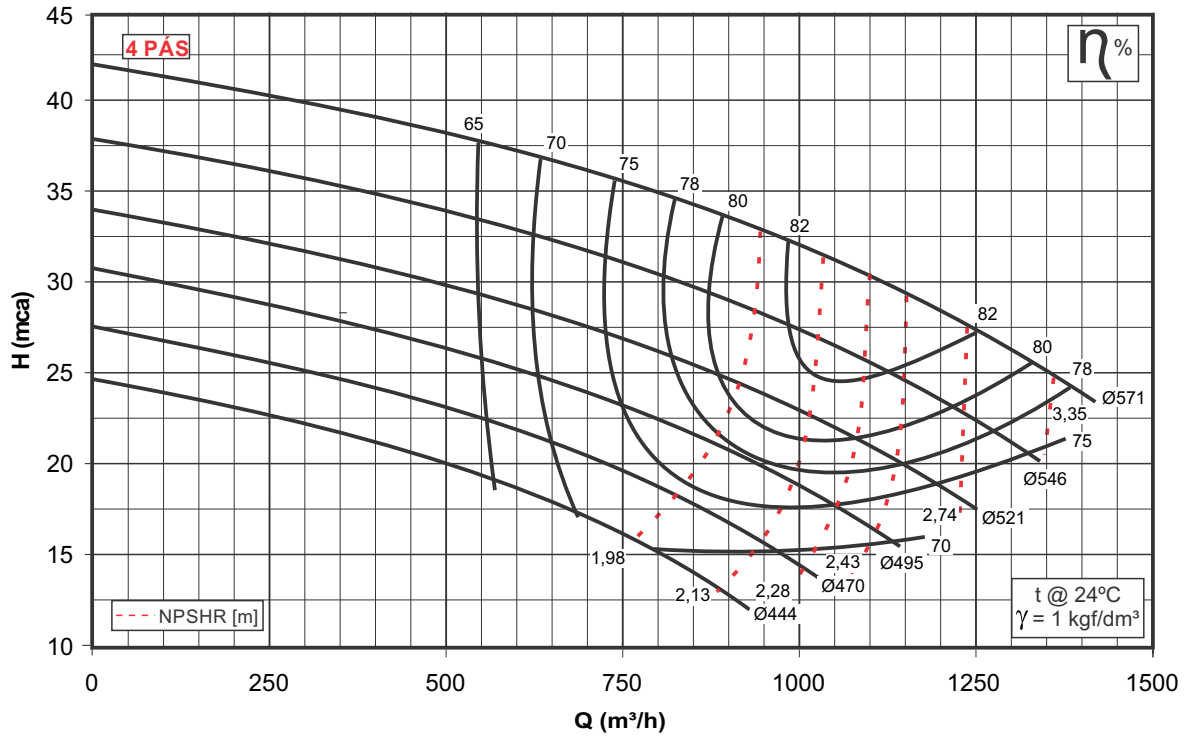

BMS 12X14X22

880 RPM

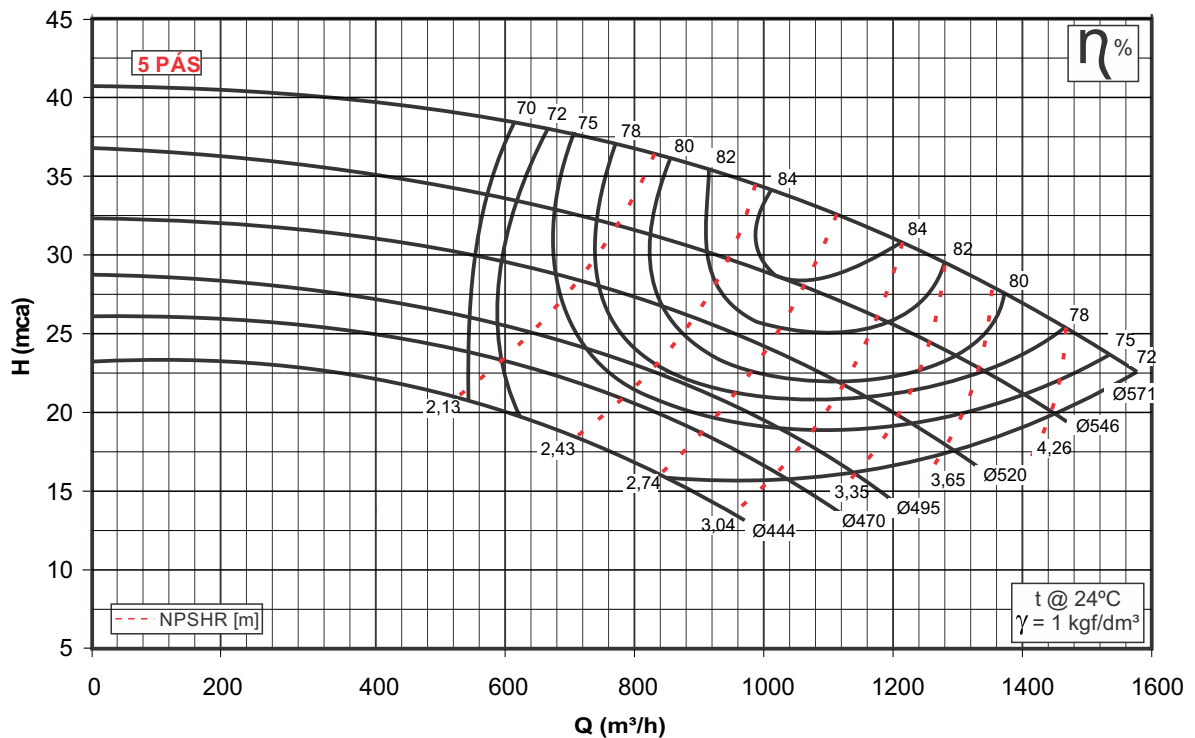



BMS 14X14X18

880 RPM

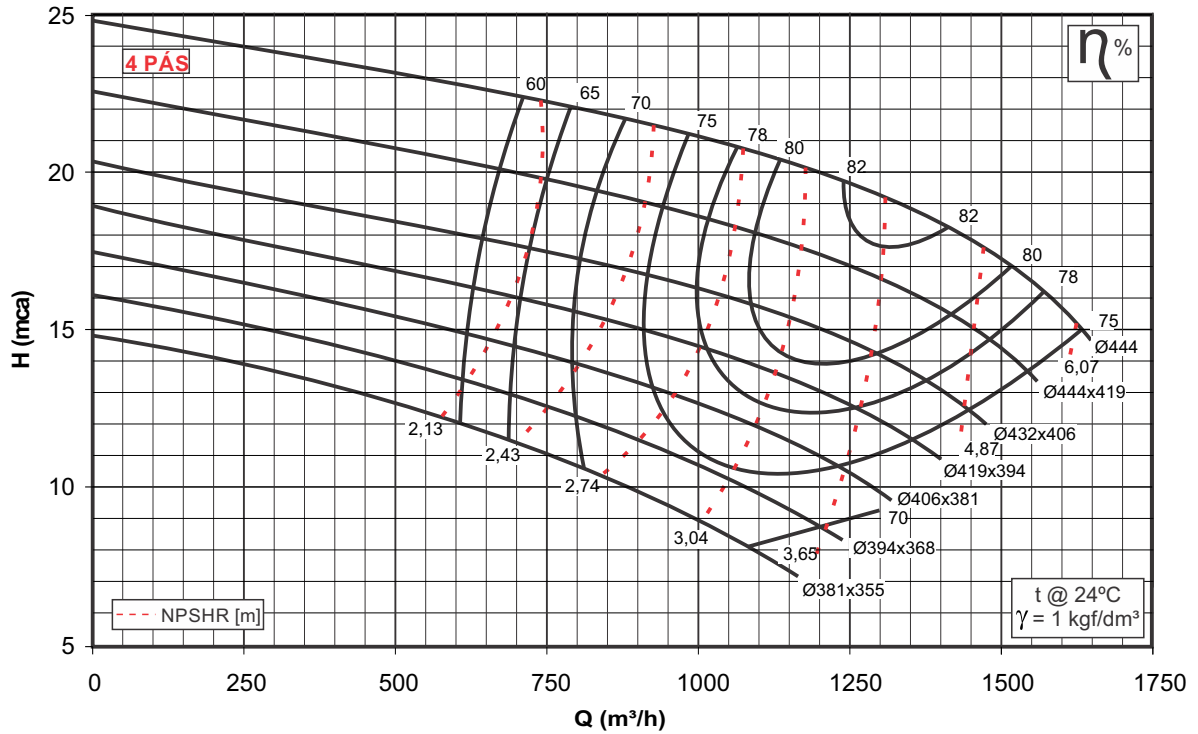

BMS 14X14X22

880 RPM

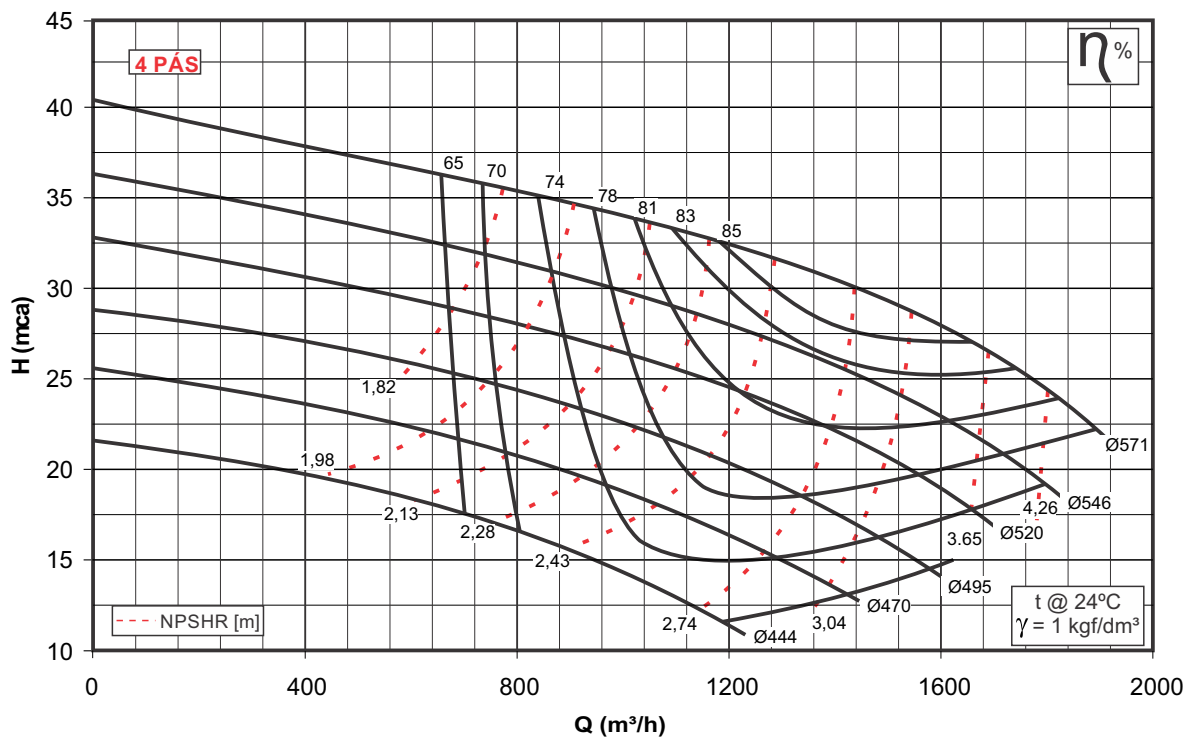



BMS 14X14X22

880 RPM

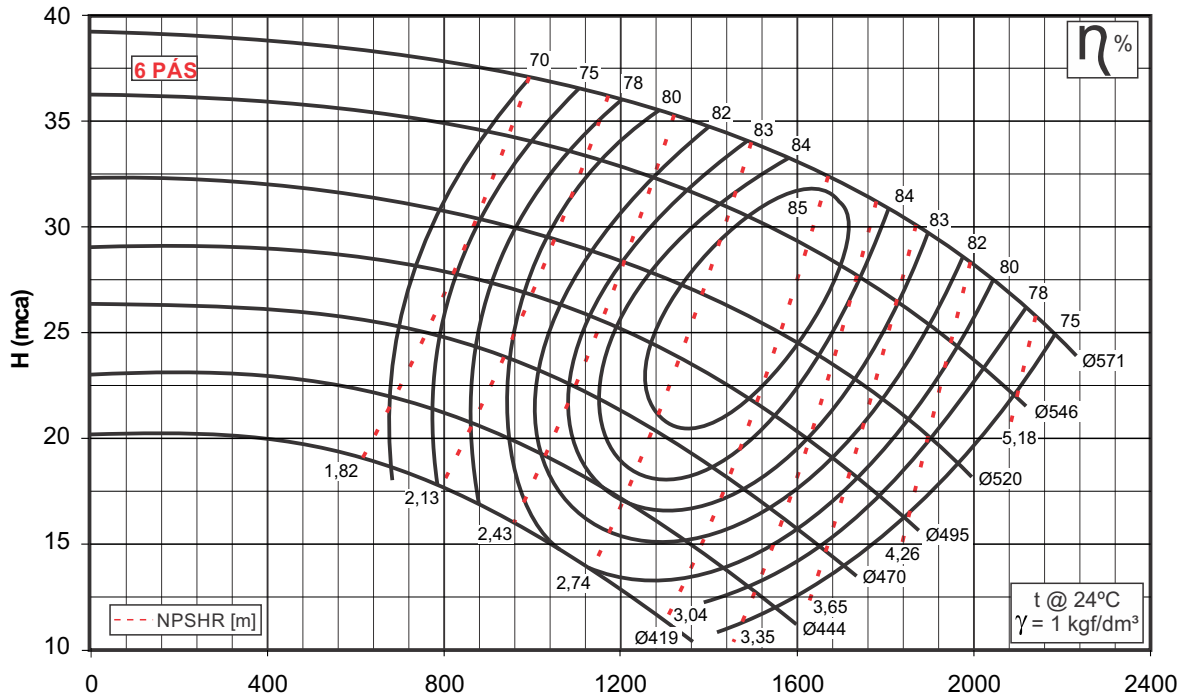

BMS 18X18X22

880 RPM

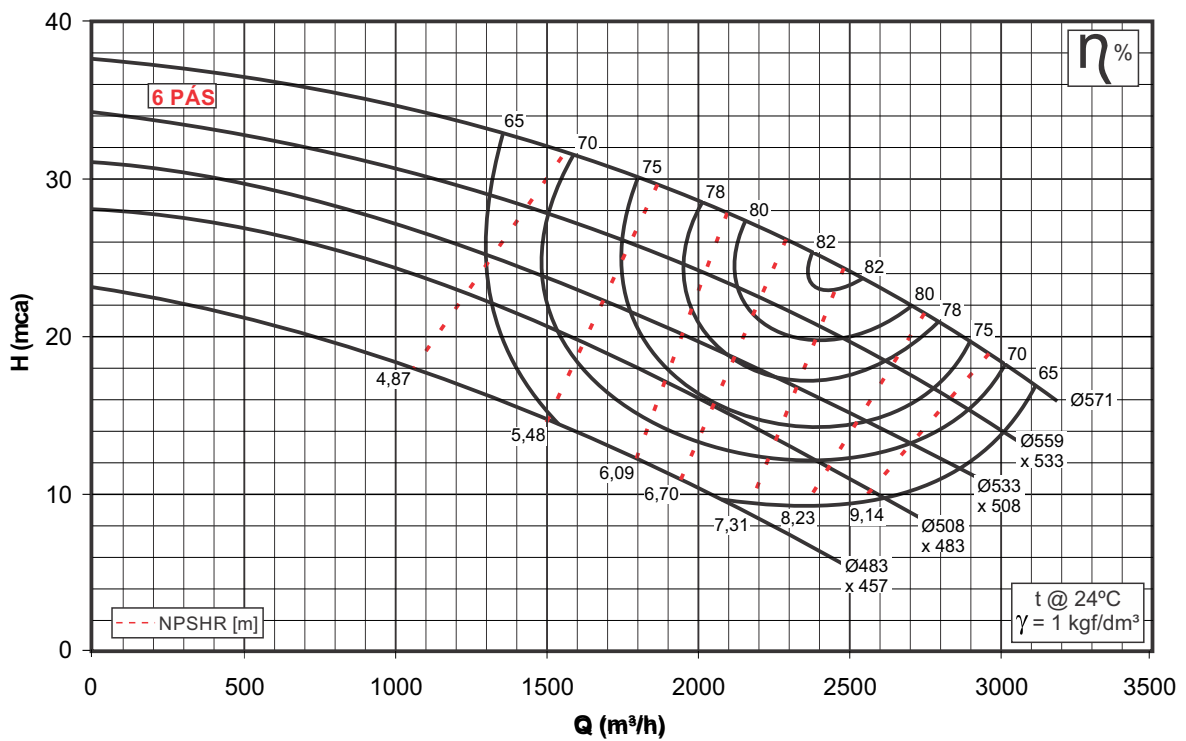



BMS18X18X22

590 RPM

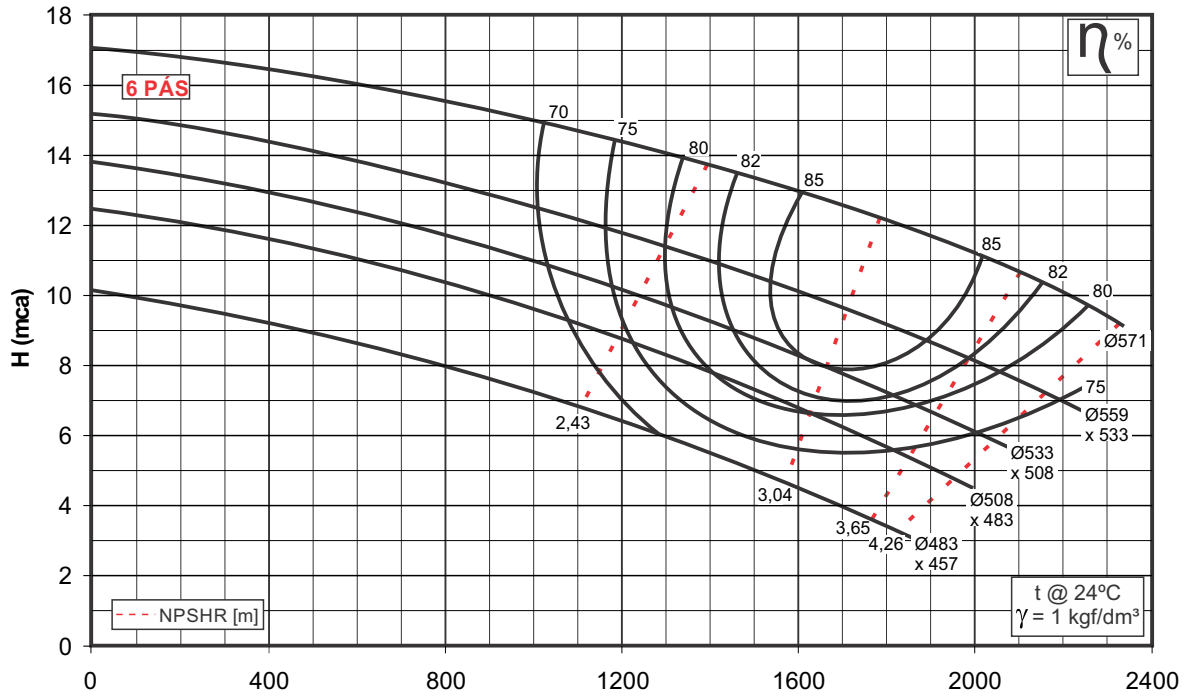

Bombas BMS

Processos de
Papel & Celulose



Bombas BMS

Processos de
Papel & Celulose



Bombas BMS

Processos de
Papel & Celulose



EMPRESA 100% NATIONAL



ÁREA 120.000M²

IMBIL – Gerando Soluções em Bombeamento.

Destacando-se no Mercado Global de Bombeamento, a IMBIL - Indústria e Manutenção de Bombas ITA Ltda, está localizada na cidade paulista de Itapira, em área própria de 120.000 metros quadrados.

Dispõe de recursos tecnológicos avançados, da prática de modernas técnicas de Administração e Engenharia e do constante desenvolvimento das Competências, Habilidades e Atitudes dos Colaboradores.

O Sistema de Gestão da Qualidade é certificado no padrão internacional ISO 9001- 2000 pelo “Bureau Veritas Certification”.

Atualmente a Imbil acelera o desenvolvimento do seu Sistema Integrado de Gestão Sócio-Ambiental.

As funções Comerciais, Administrativas e Industriais são totalmente interligadas por software de Gestão Empresarial em uma rede com mais de uma centena de estações conectadas por fibra ótica e wireless.

Suportada por duas Fundições e Modelação próprias, a Imbil é auto-suficiente na produção de seus fundidos, atendendo aos mais variados materiais, especialmente aos resistentes a abrasão e corrosão.

A Manufatura Enxuta - filosofia que visa reduzir o tempo existente entre a colocação do pedido e a expedição do produto - resulta em maior flexibilidade e menores prazos de entrega aos clientes.

Oferece um adequado e personalizado atendimento Pós-Venda, desde a fase de Start-up até a manutenção integral do equipamento, e ainda, mediante Contrato de Serviços, opera Instalações de Bombeamento em Usinas de Açúcar e Alcool, Siderúrgicas, Mineradoras e plantas industriais em geral.

Todo esse conjunto de Recursos humanos, tecnológicos e financeiros estão dirigidos para a MISSÃO IMBIL de "Prover soluções em Bombeamento e seus Serviços Associados, de forma a atender as necessidades e anseios de seus Clientes no mercado global”, respeitando os princípios éticos que regem as suas relações com Colaboradores, Parceiros, Meio Ambiente e Sociedade.

www.imbil.com.br



Pabx (19) 3843-9833

DDG 0800 148500

ivendas@imbil.com.br
